

**Colour-blocked Top**

Project design © Love Productions 2016  
This design is protected by copyright and  
must not be made for resale.

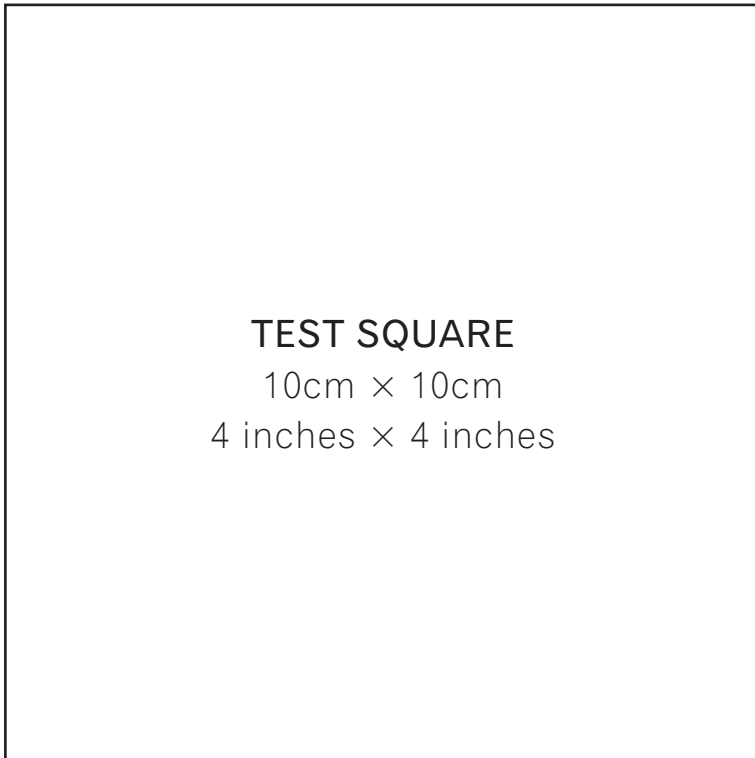

**TEST SQUARE**  
10cm × 10cm  
4 inches × 4 inches

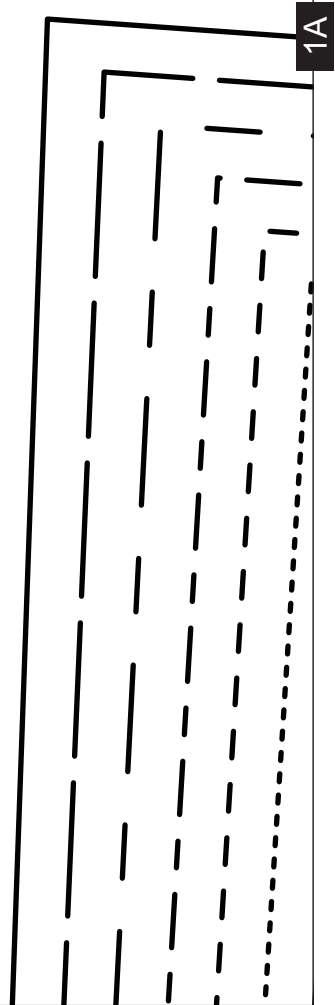

**1B**

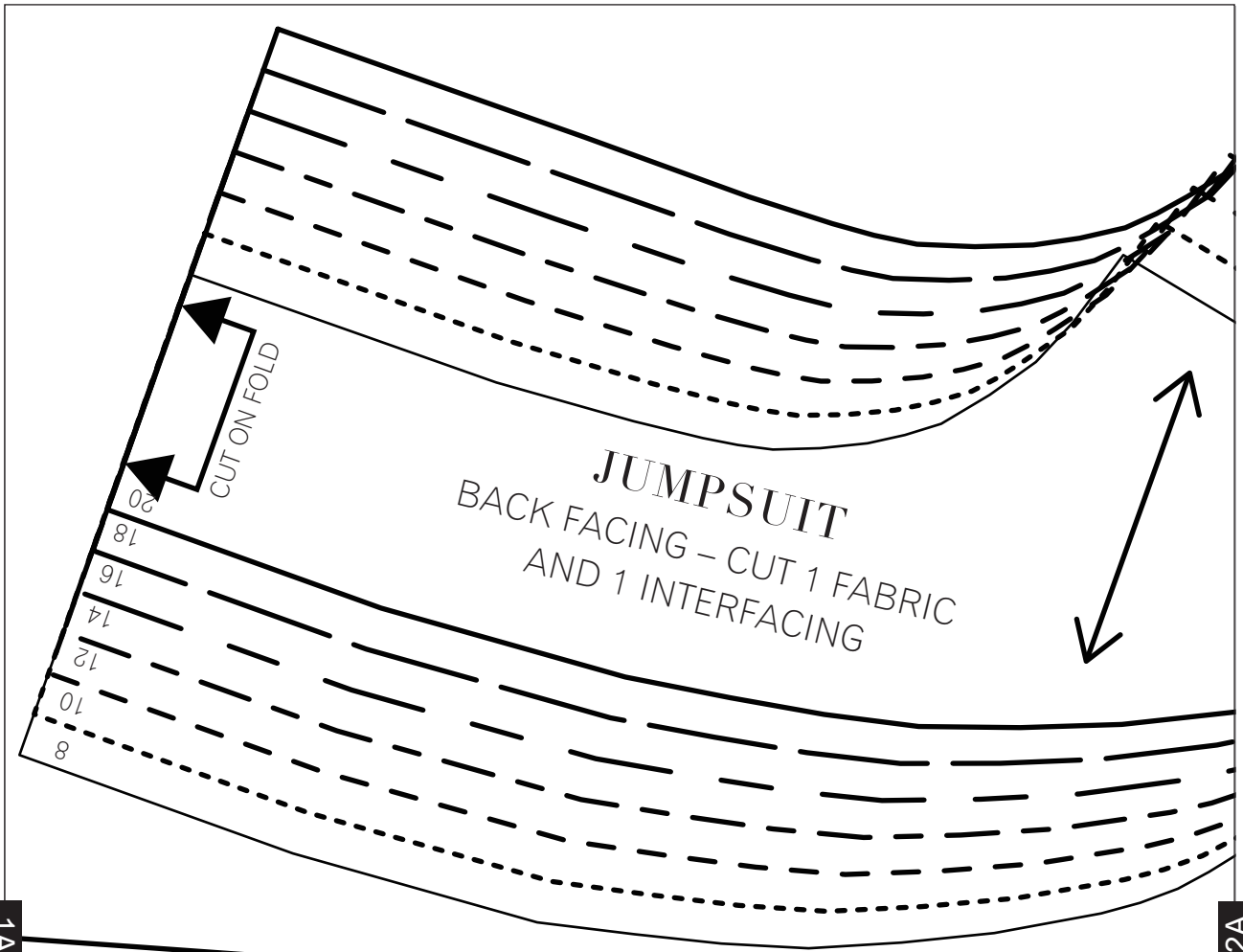

1A

2A

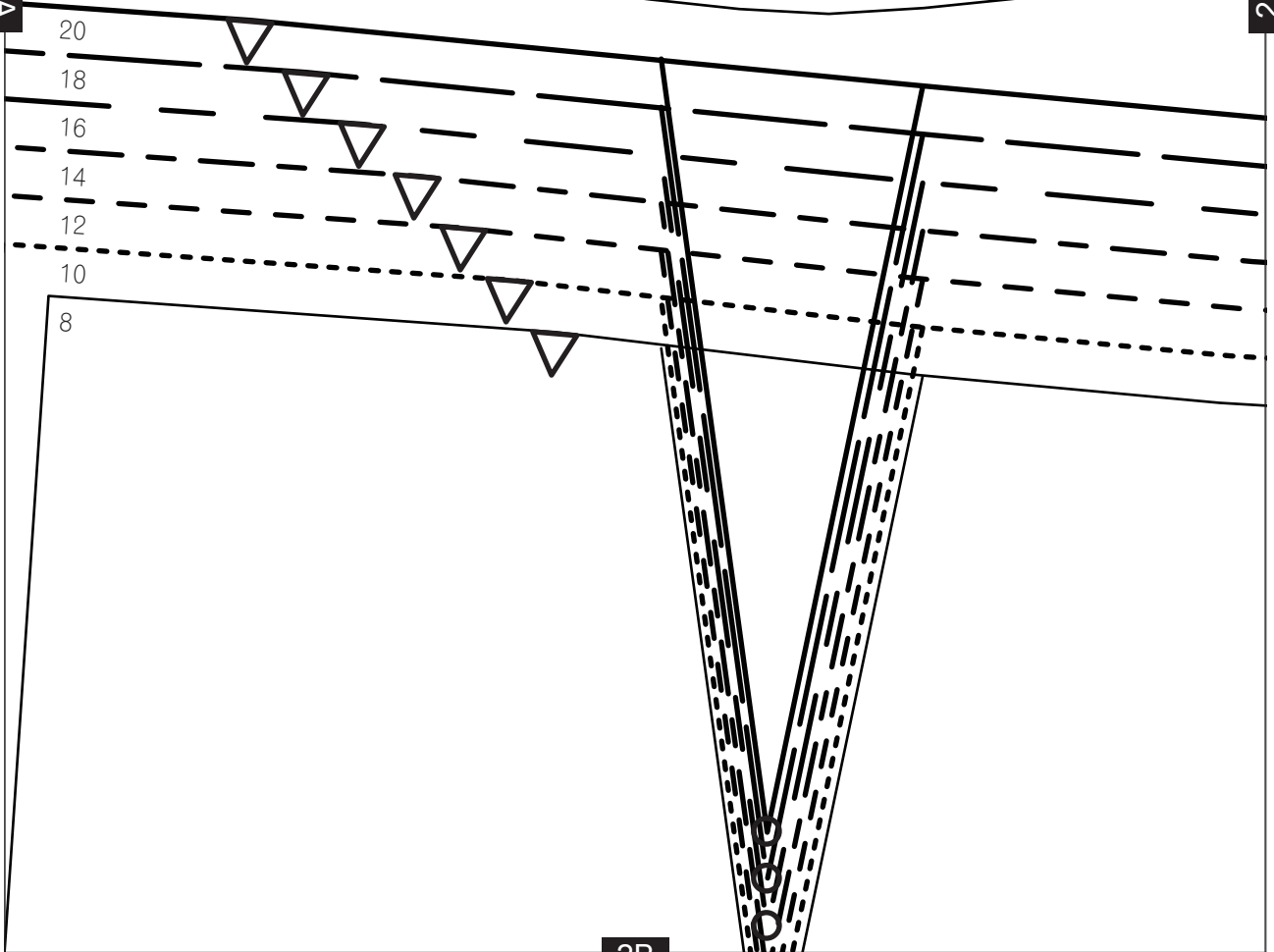

2B

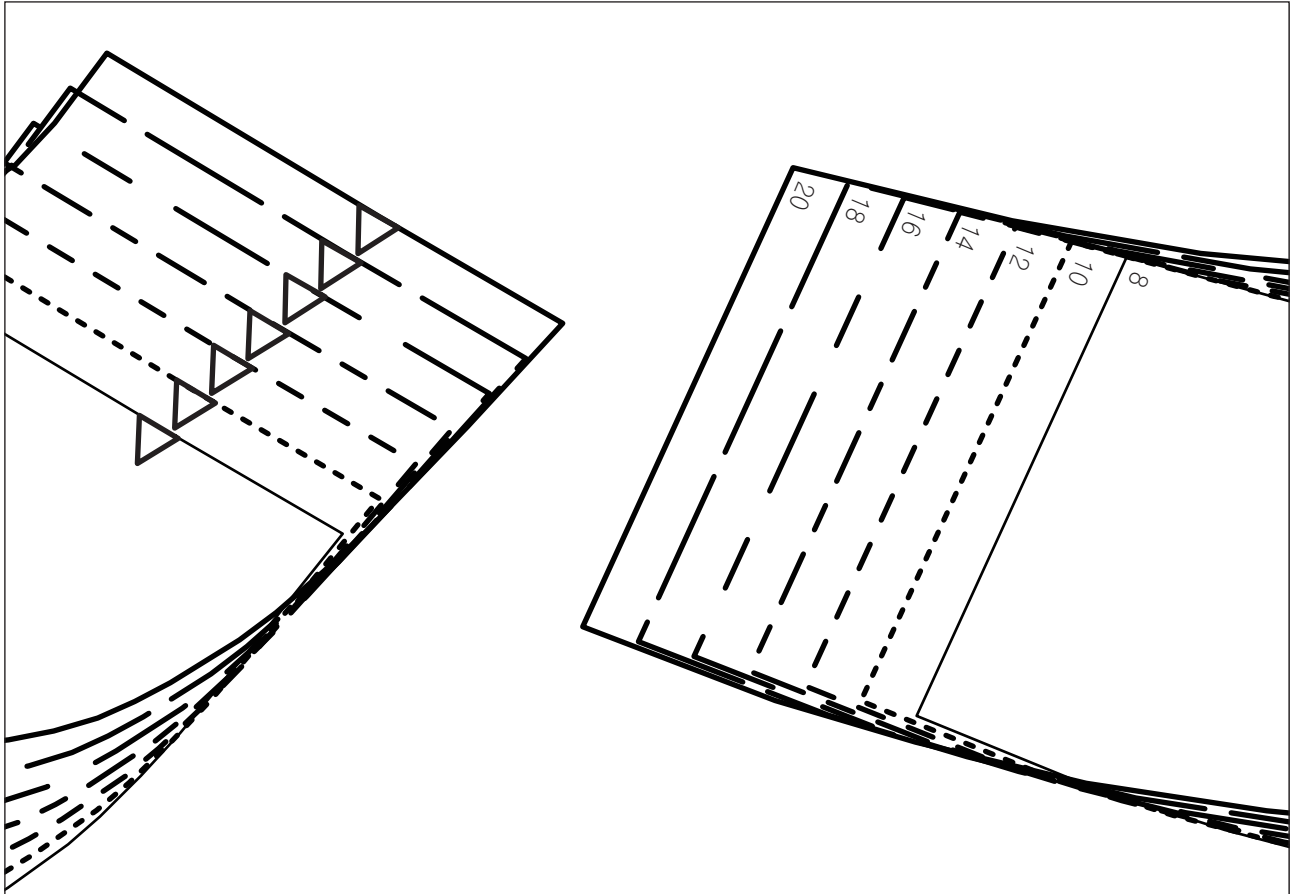

2A

3A

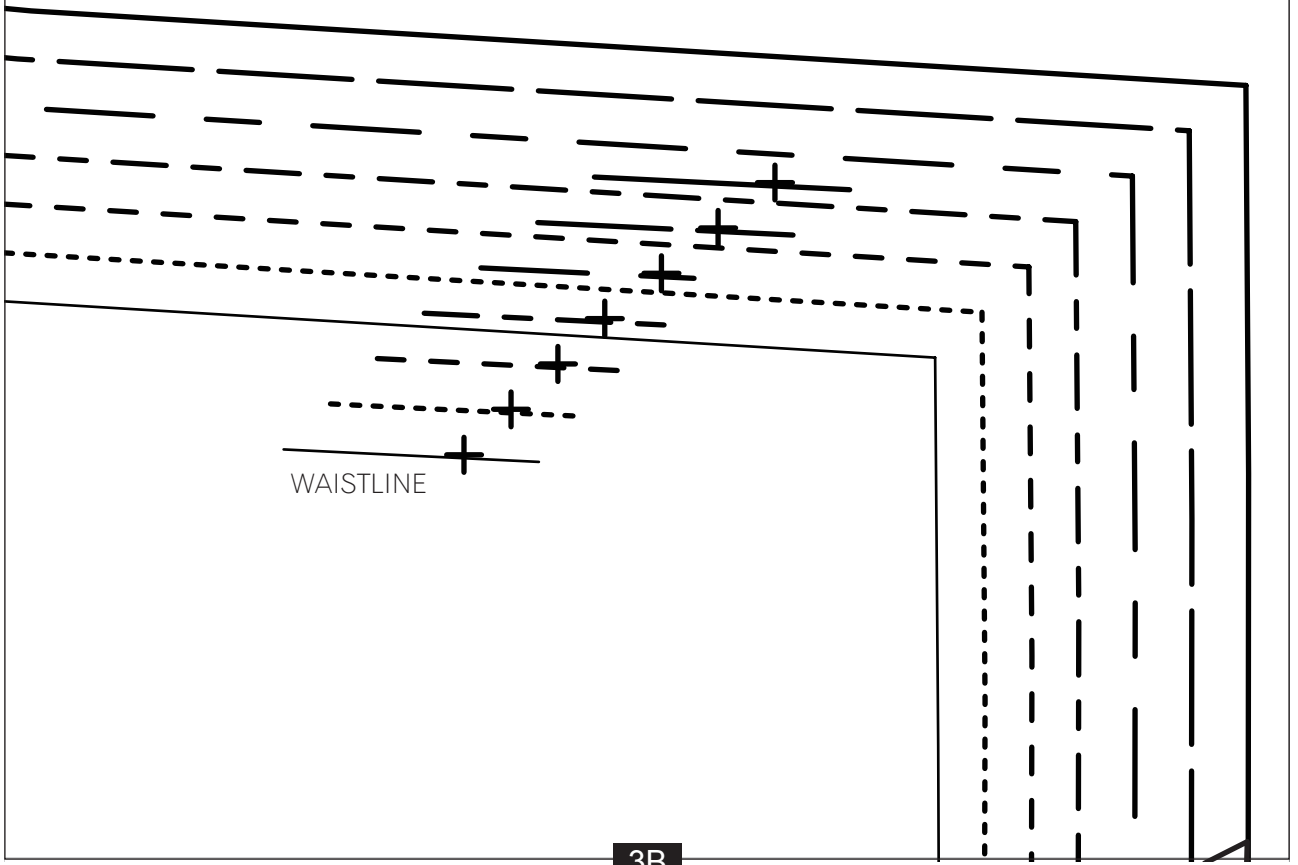

3B

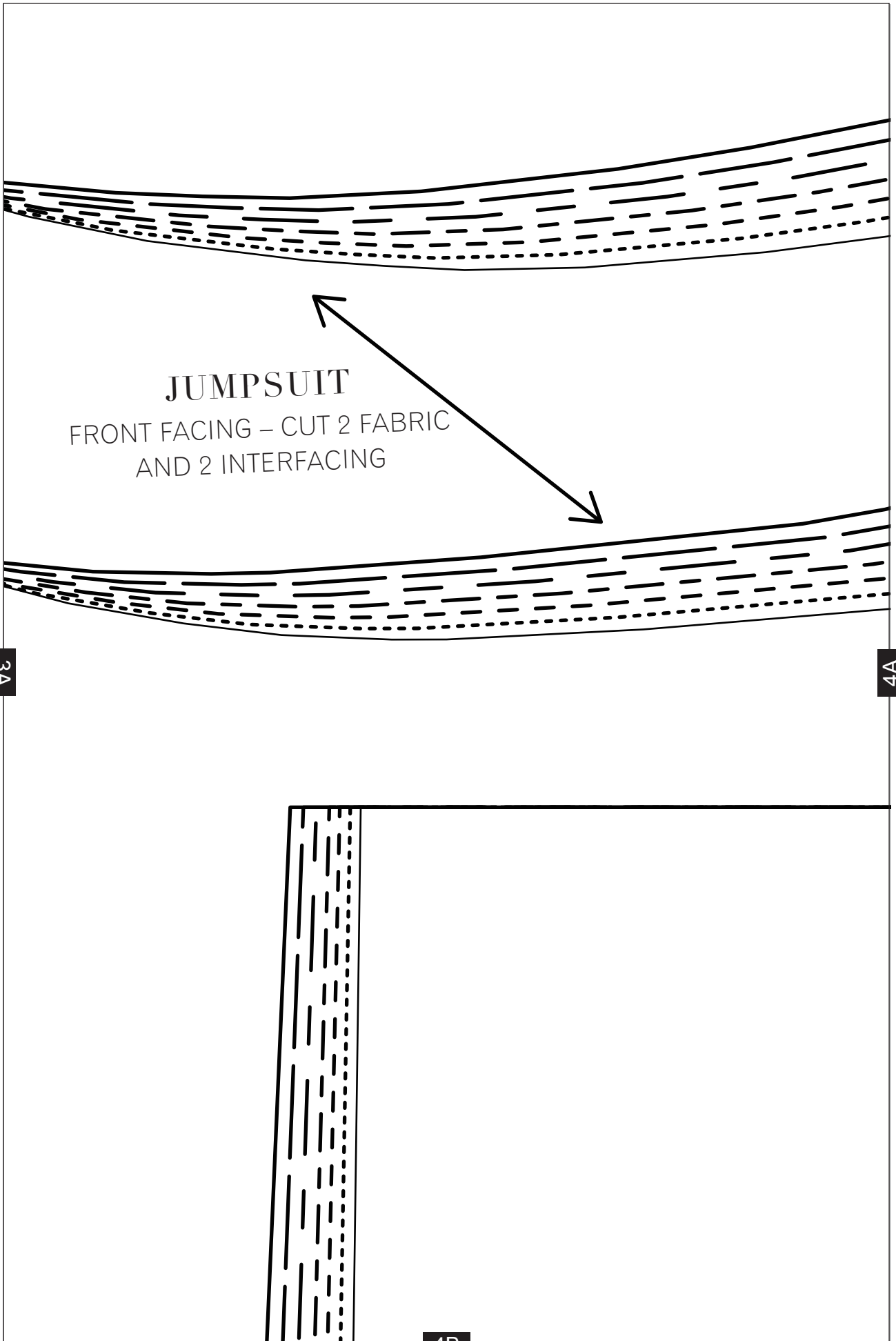

JUMPSUIT  
FRONT FACING - CUT 2 FABRIC  
AND 2 INTERFACING

3A

4A

4B

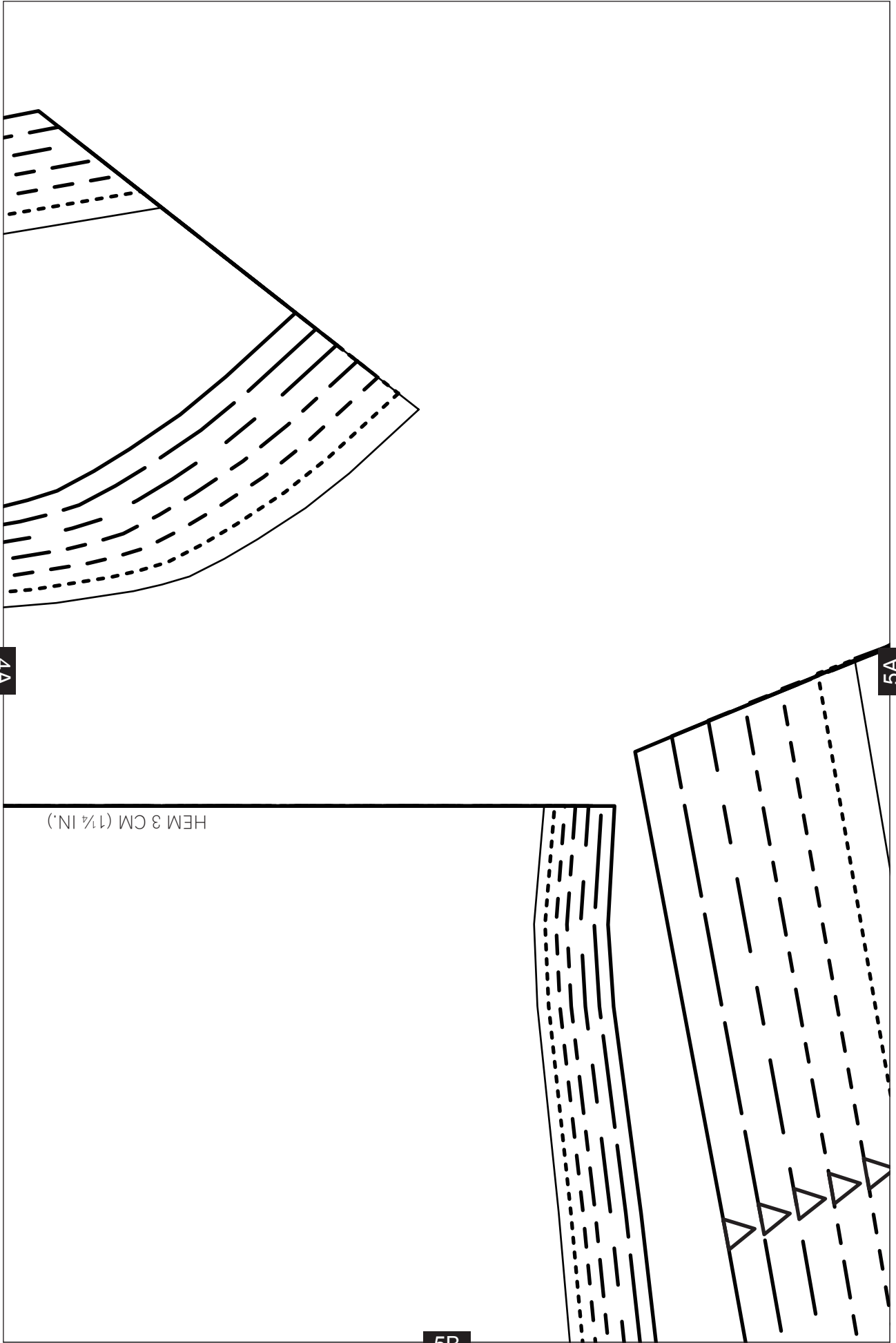

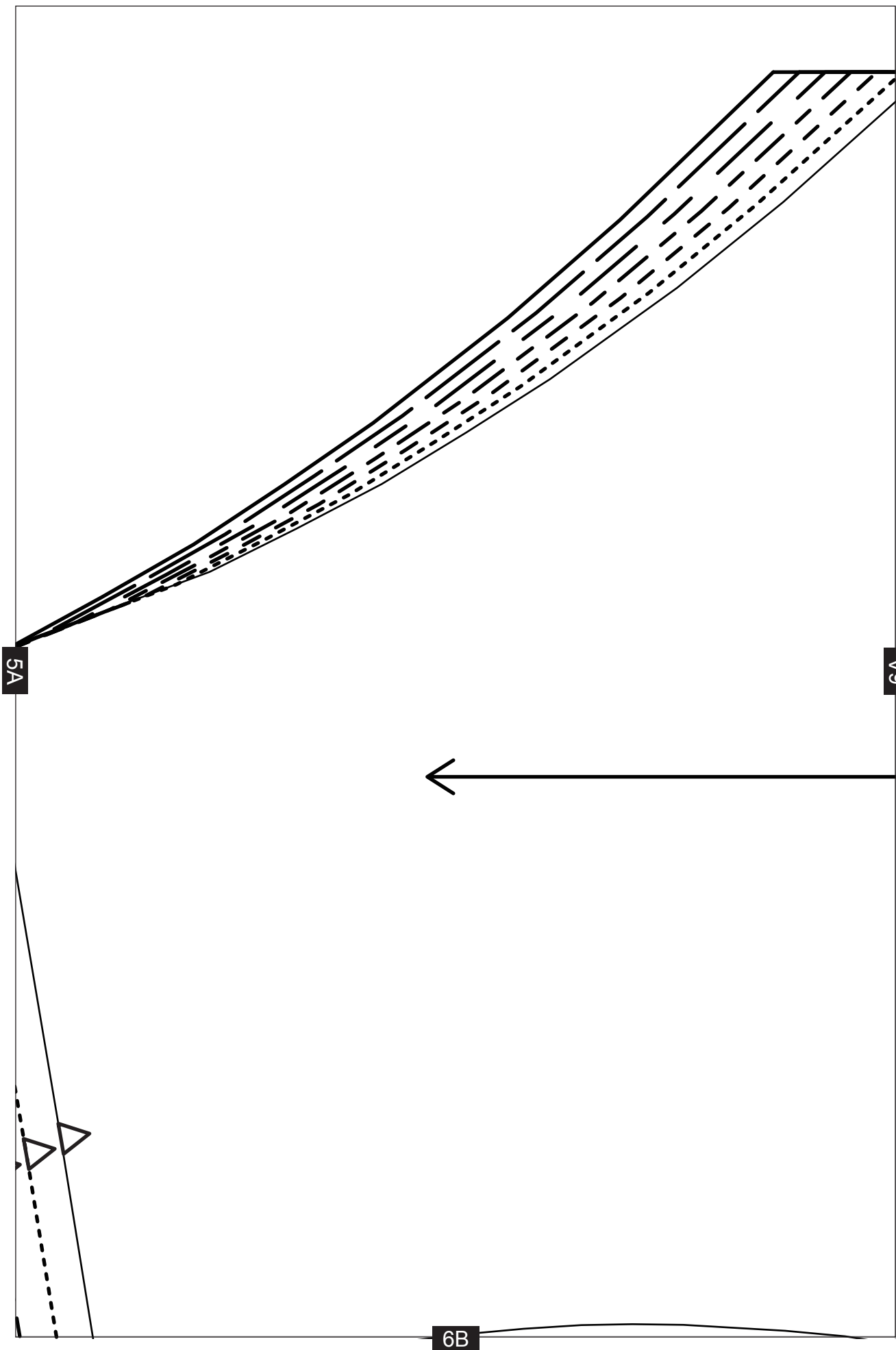

# JUMPSUIT

TOP FRONT – CUT 2

6A



7A

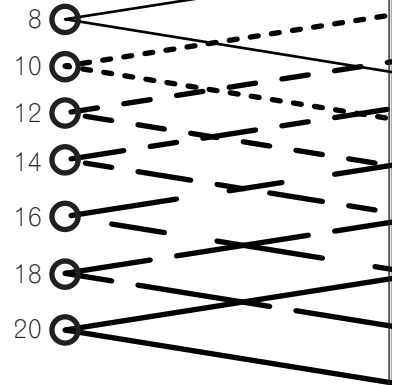

7B

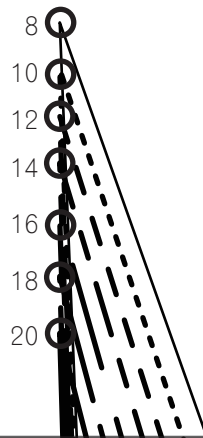

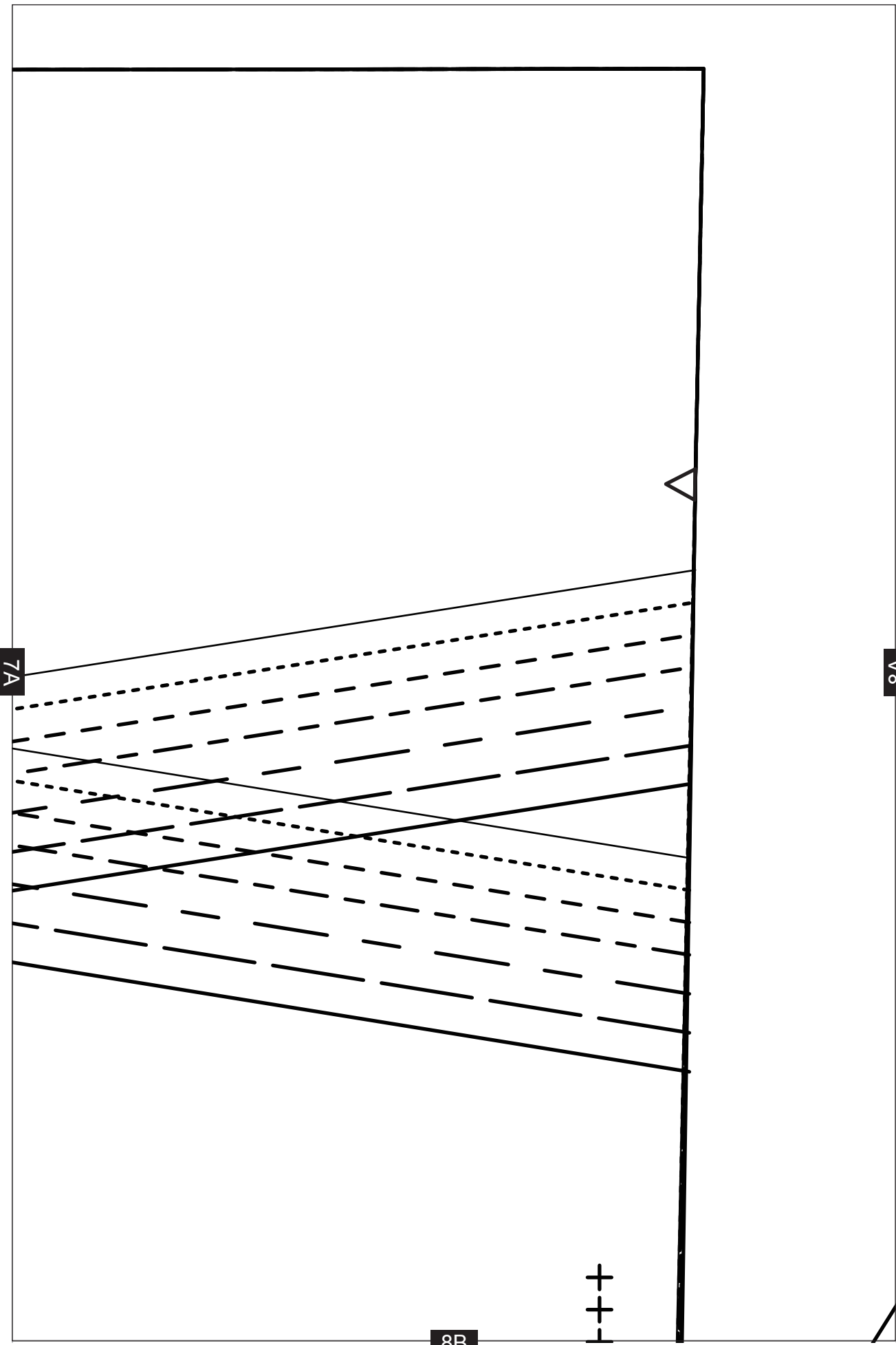



8A

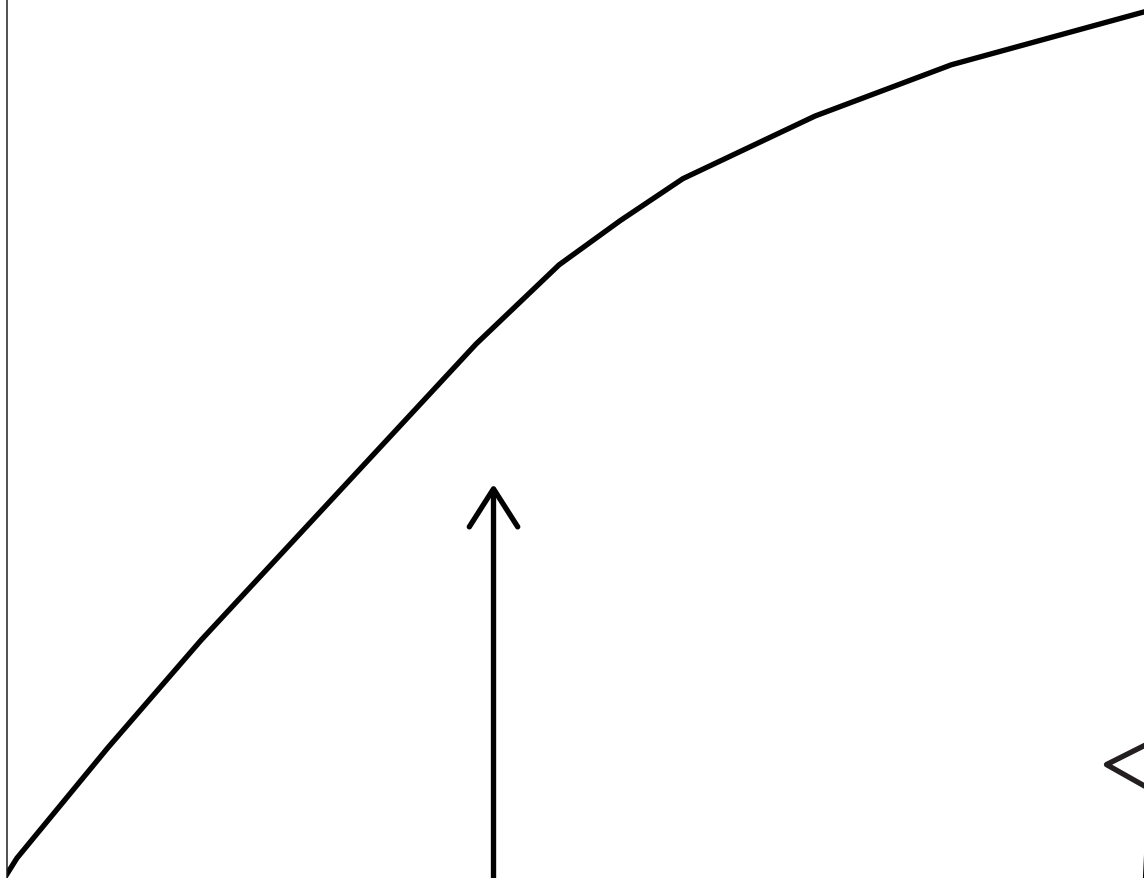

9B

1B

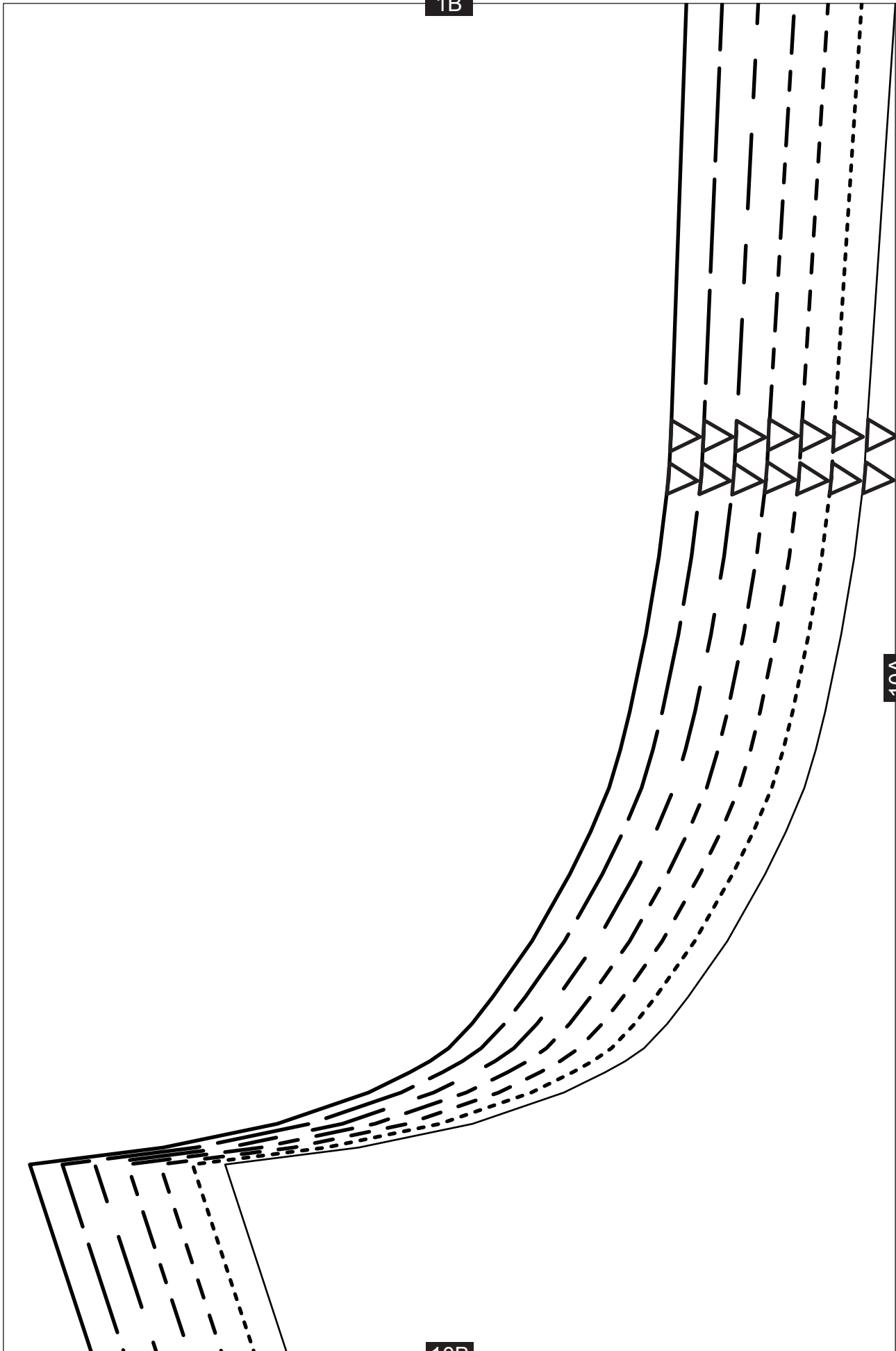

10A

10B

10A

**JUMPSUIT**  
TROUSER BACK – CUT 2



11B

2B



11A

11A

3B

12A

12B

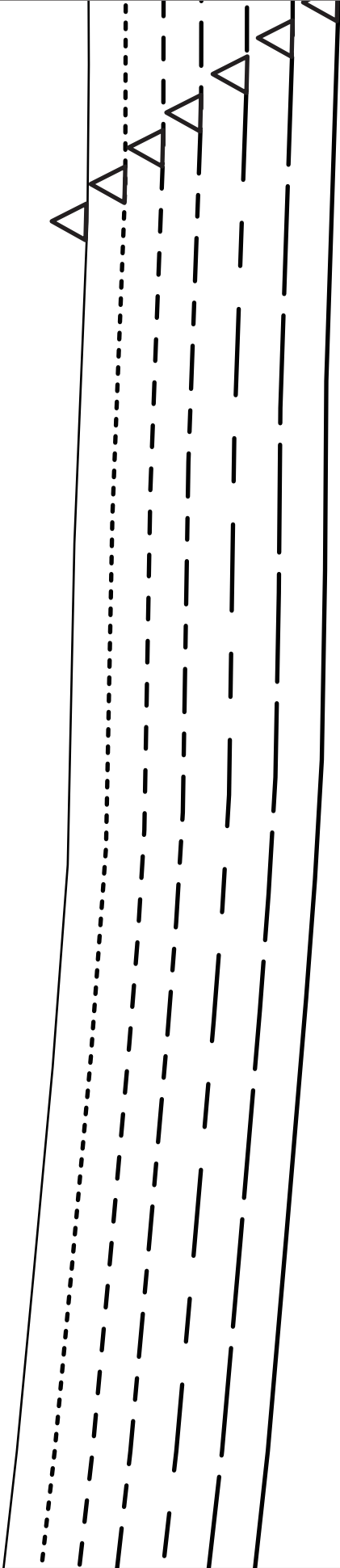

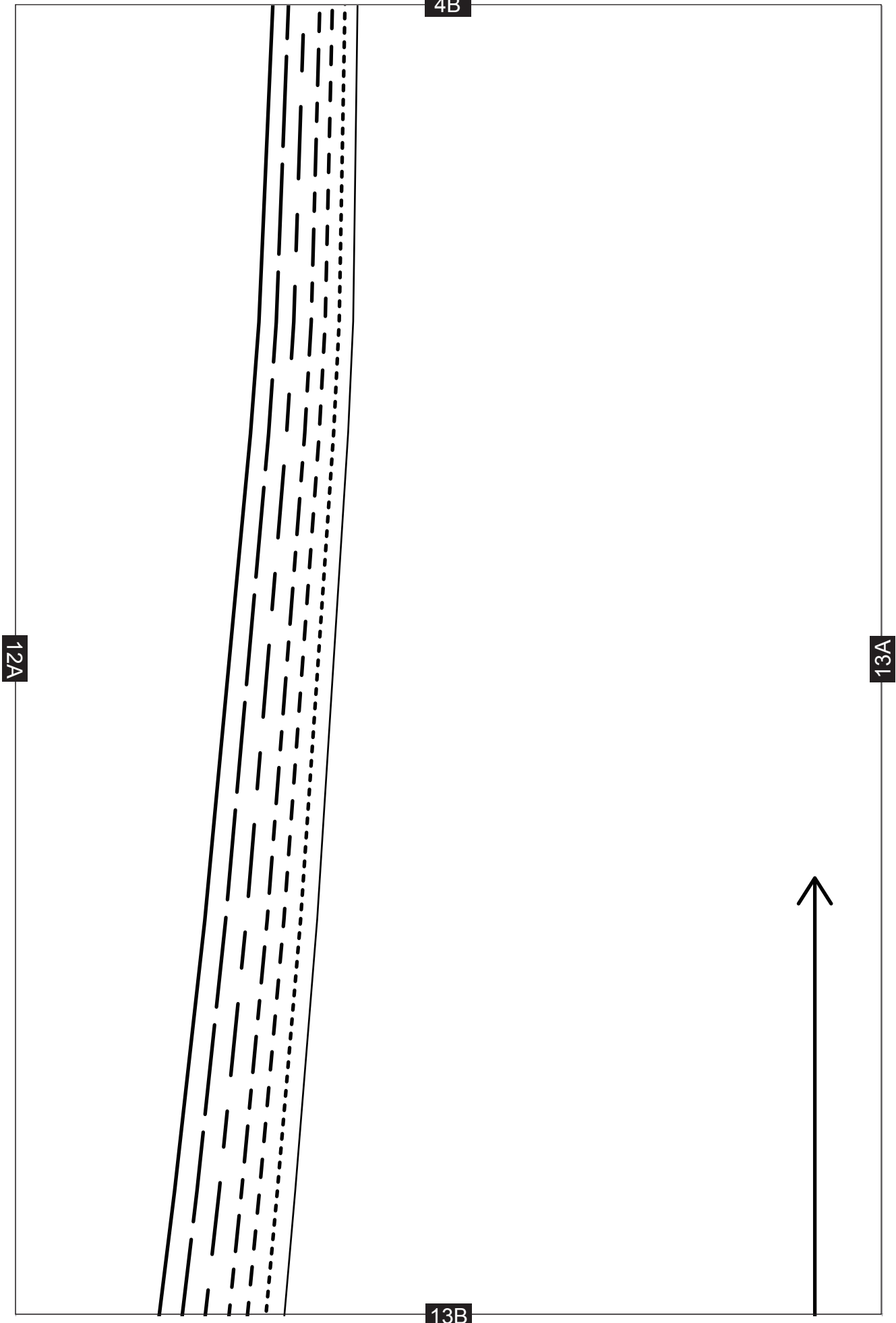

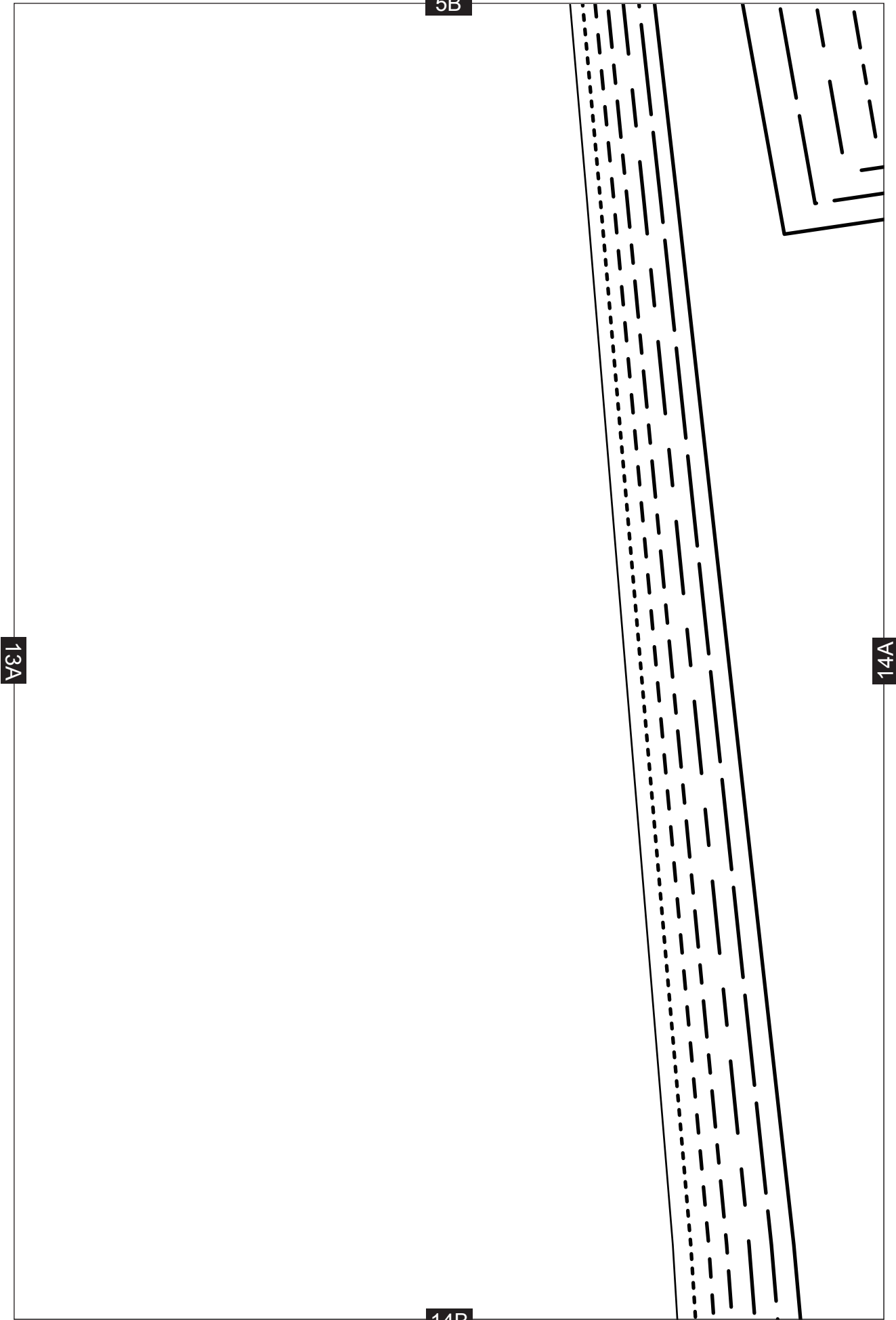

13A

5B

14A

14B

6B

14A

15A

15B

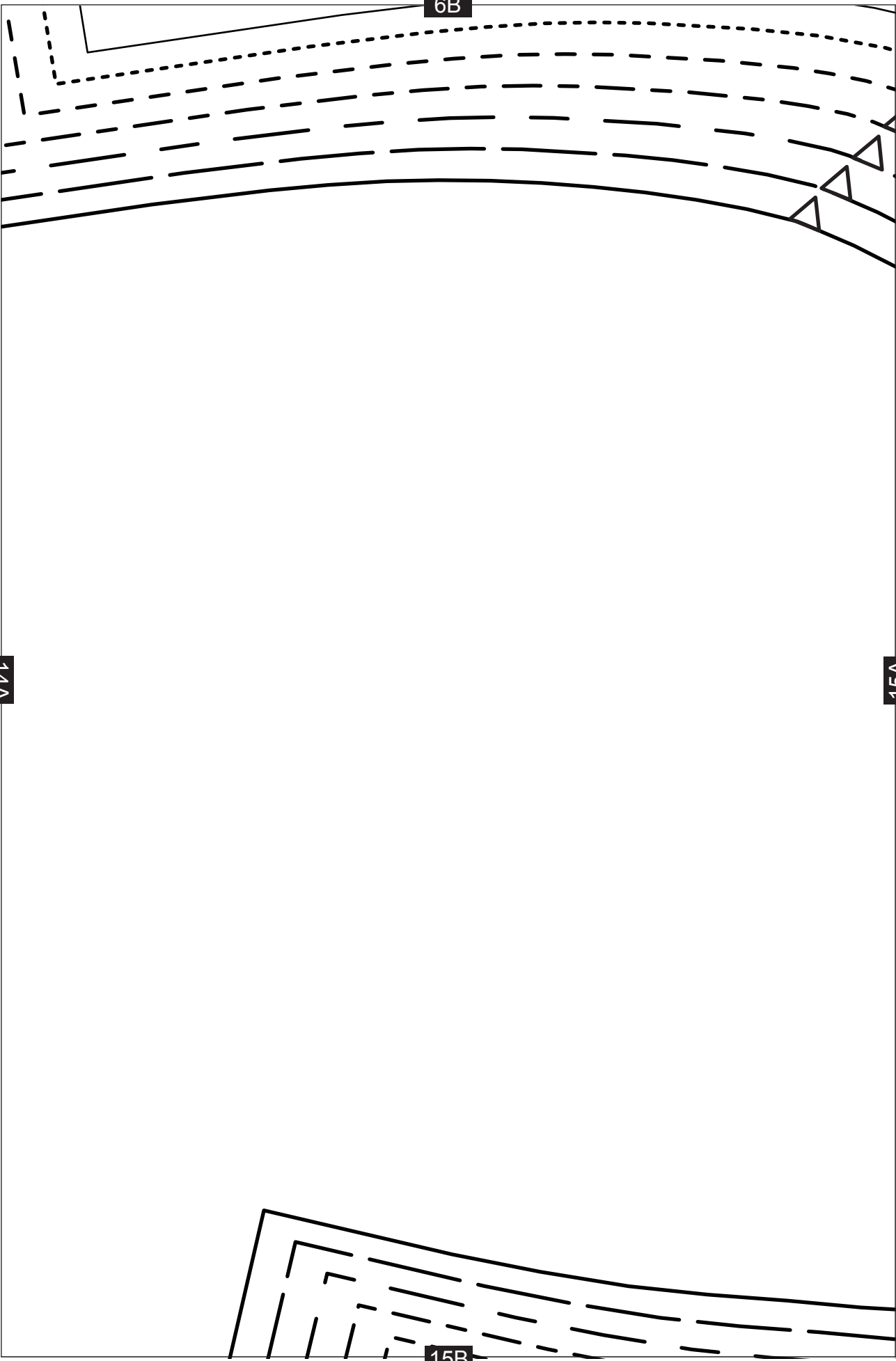

7B

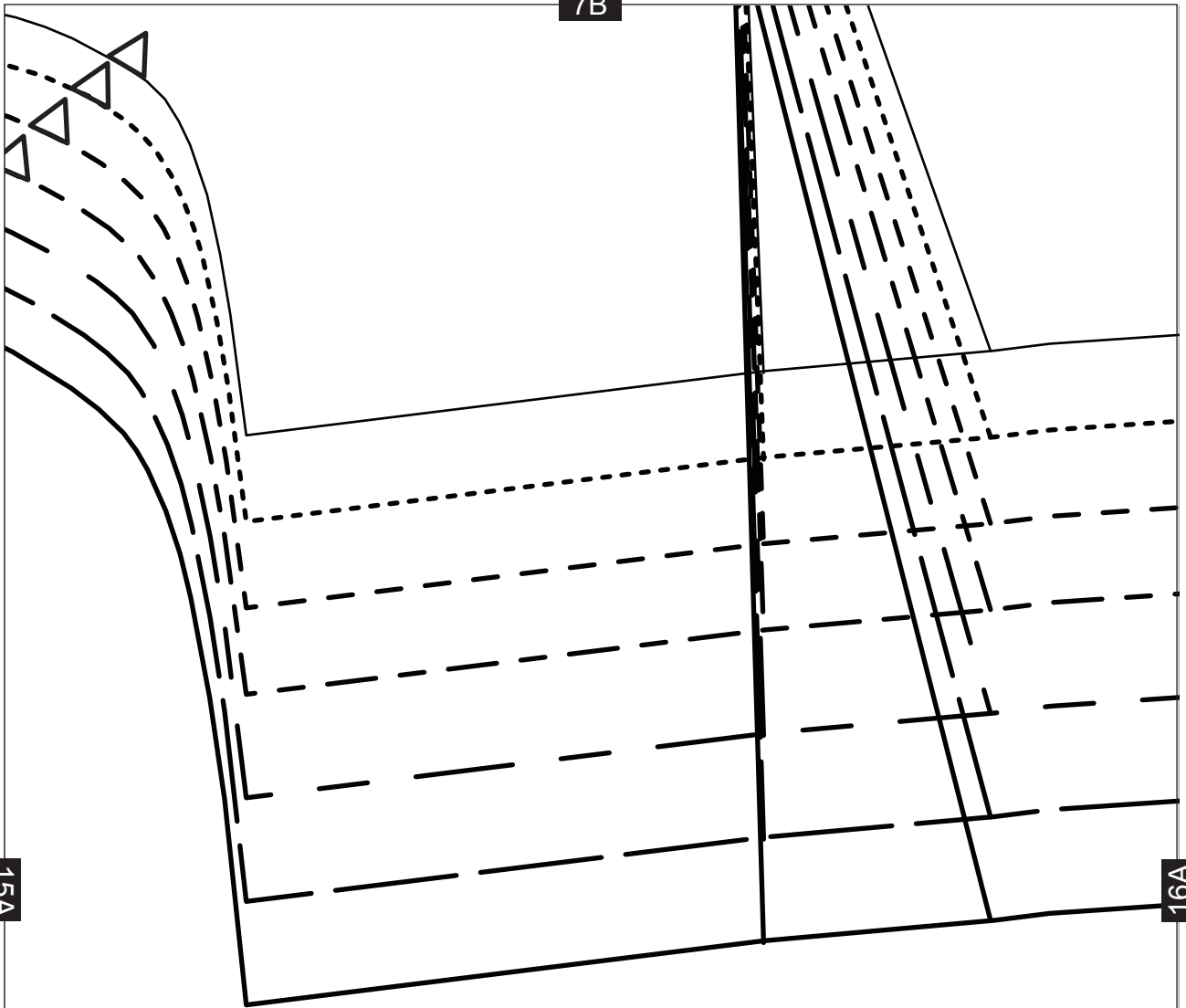

15A

16A

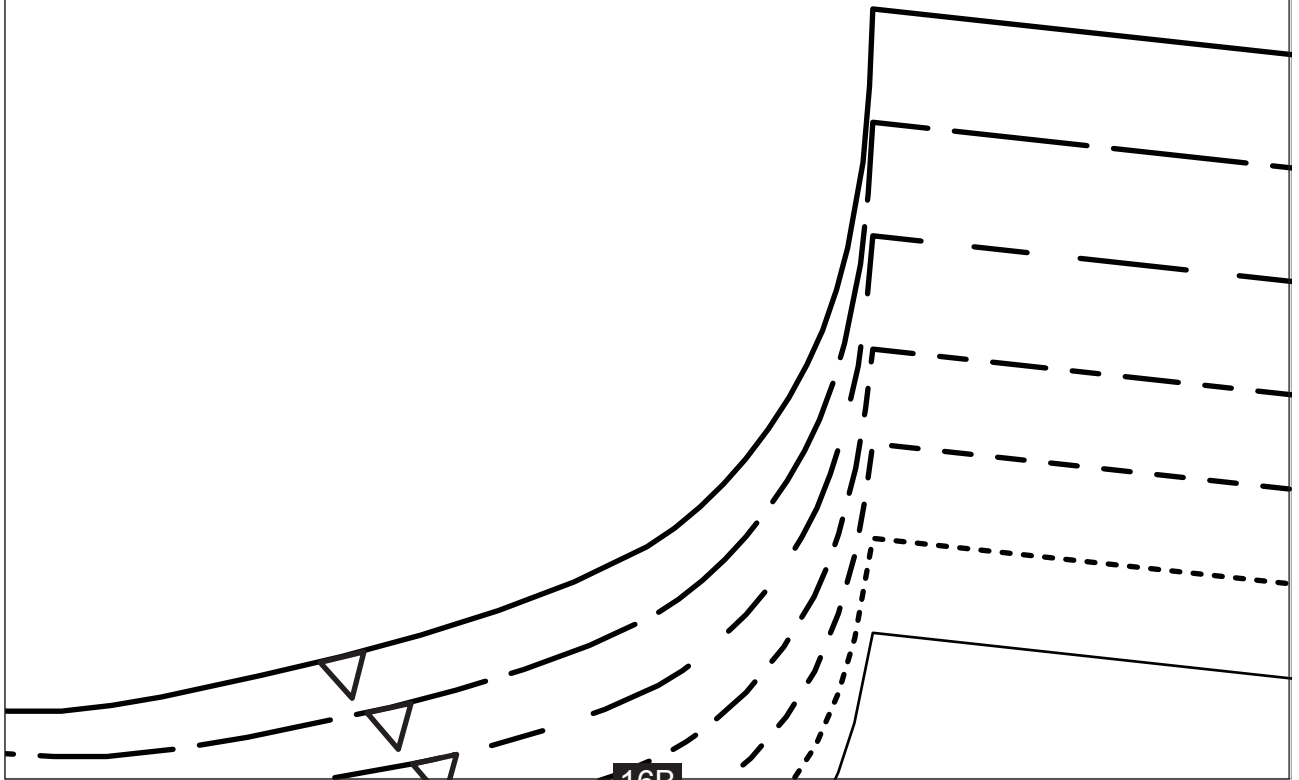

16B



8B

+

+

+

+

8

10

12

14

16

18

20

16A

17A

17B

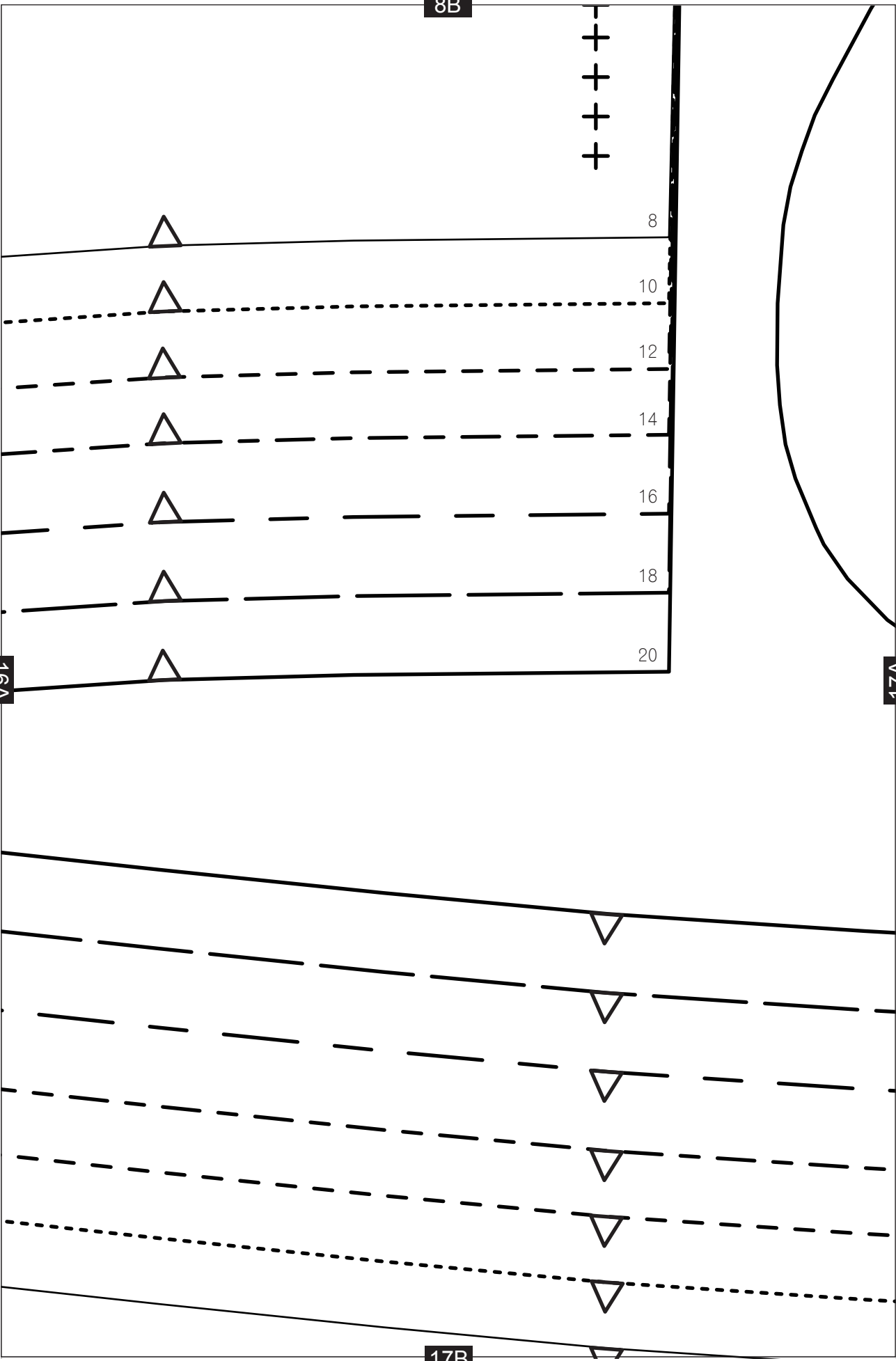

9B



JUMPSUIT  
POCKET - CUT 4

17A

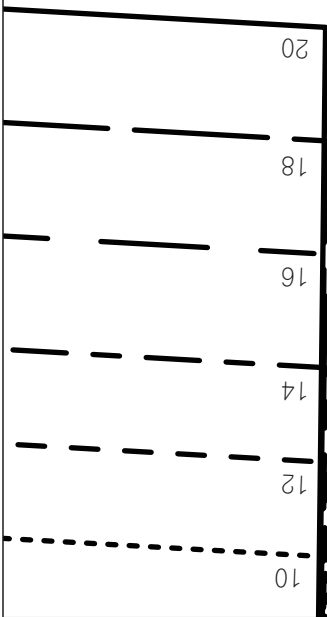

18B

10B

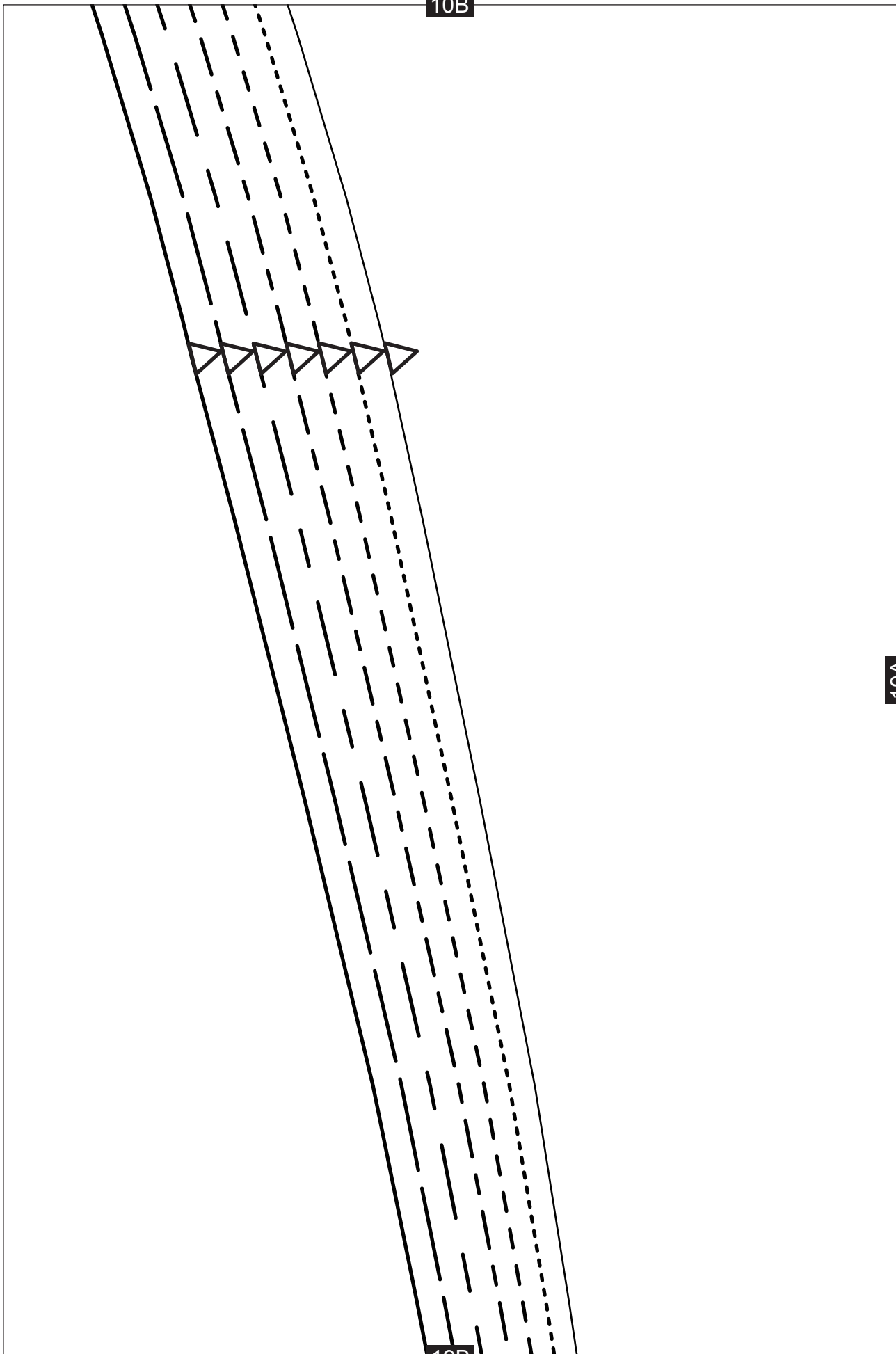

19B

19A

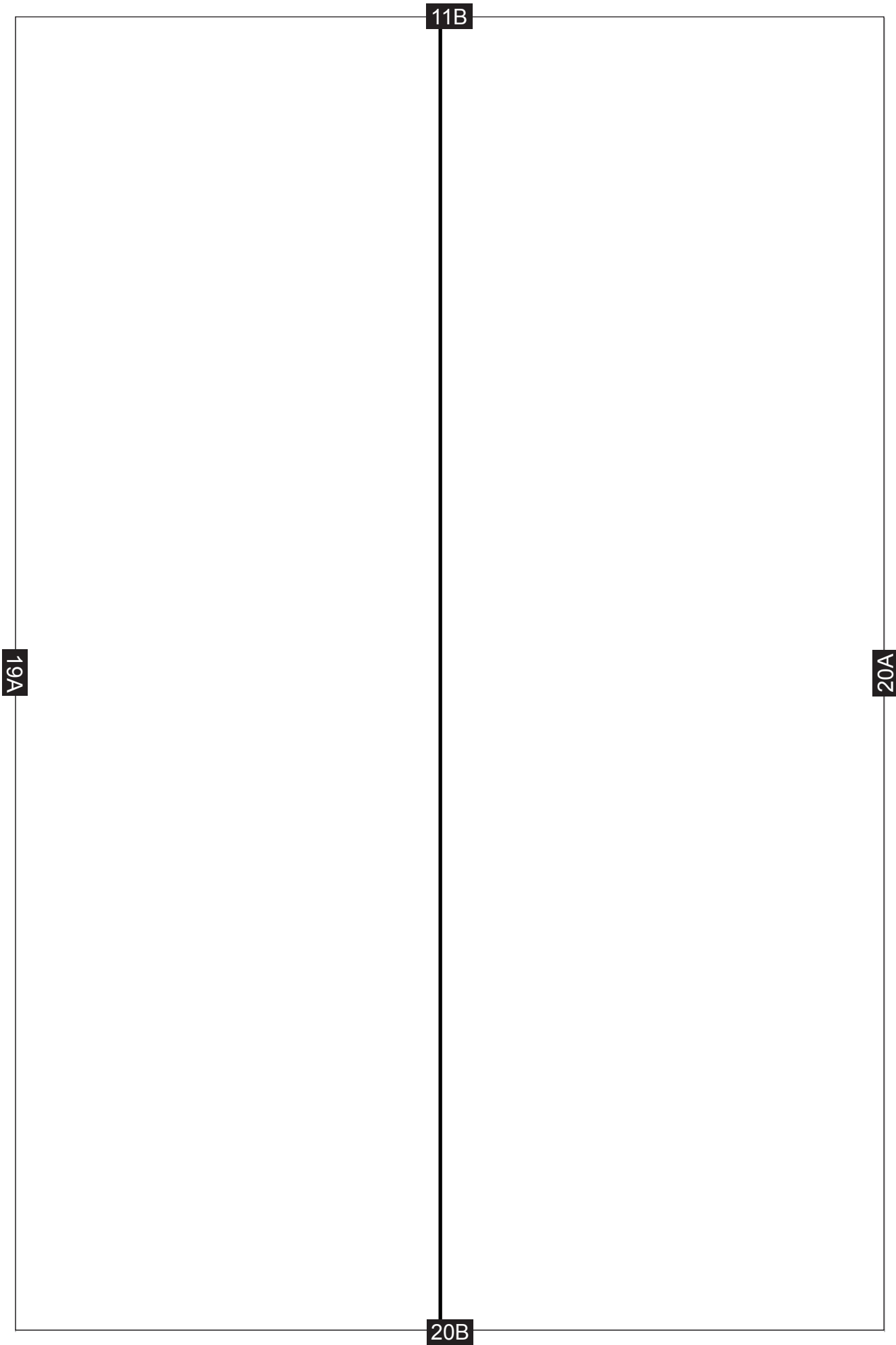

12B

20A

21A

21B

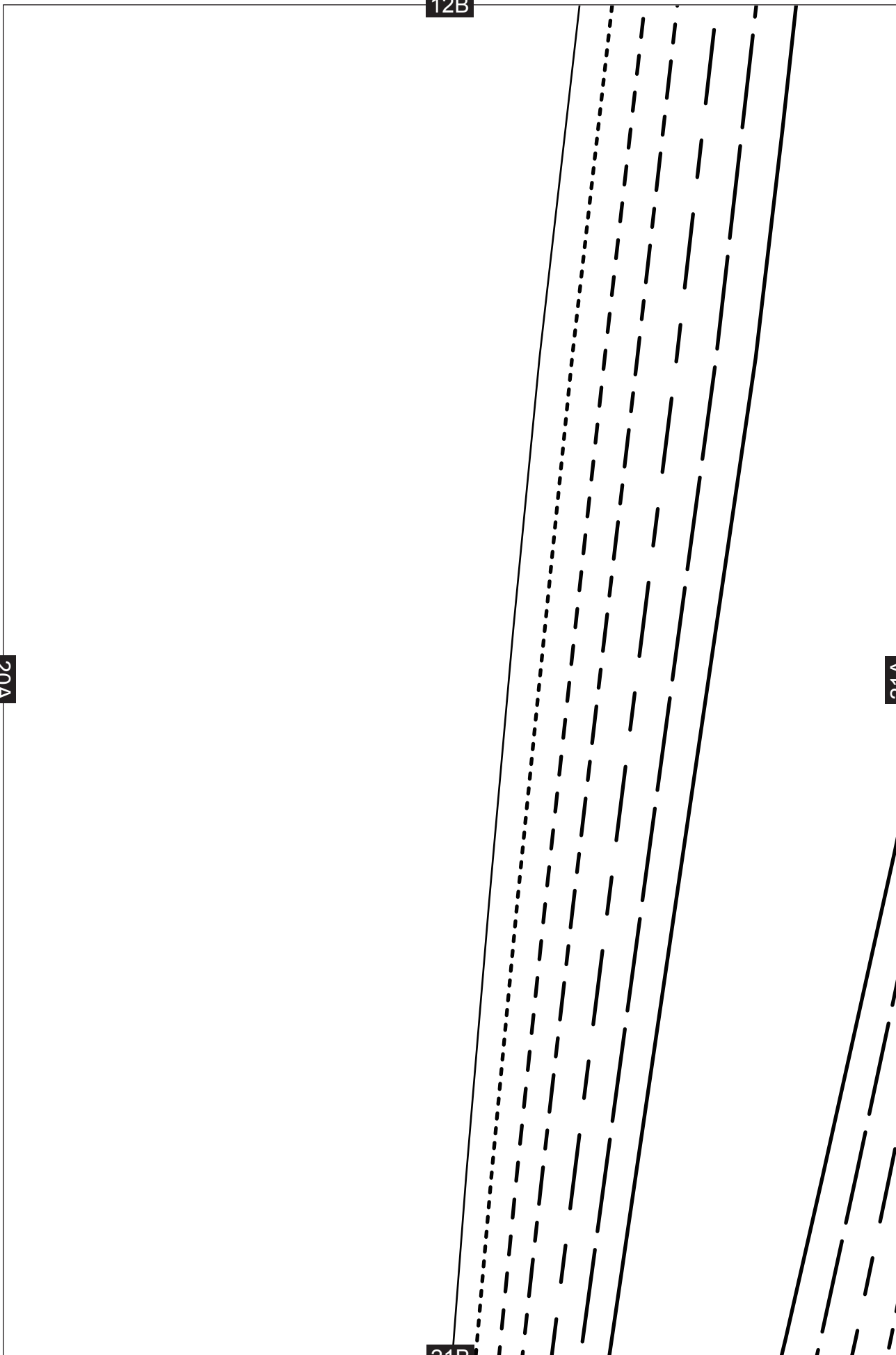

13B

21A

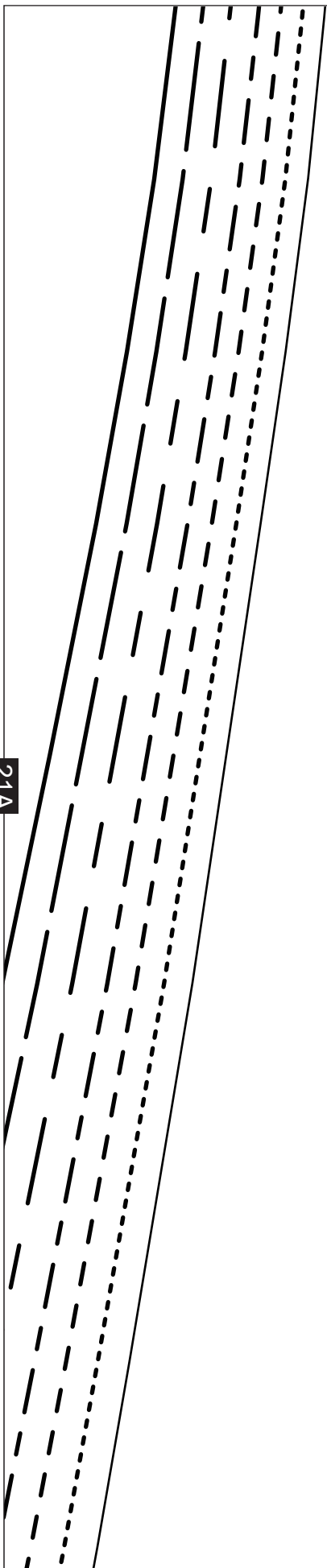

22A

22B

14B

22A

23A

23B

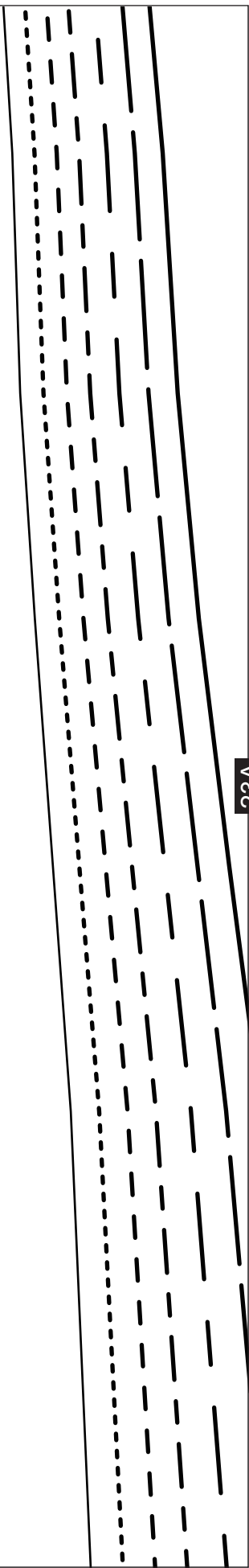

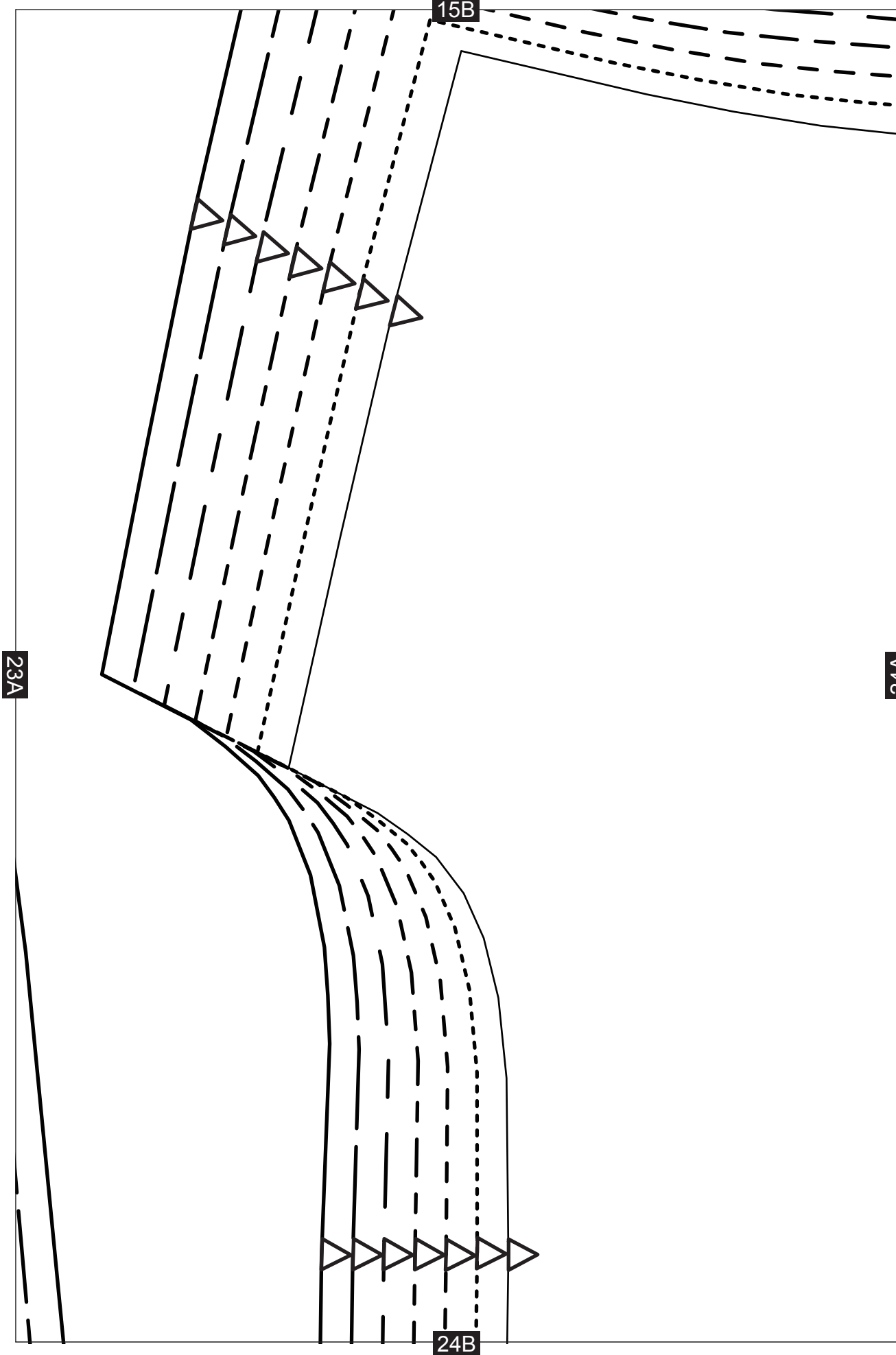



16B

24A

25A



**JUMPSUIT**  
TOP BACK – CUT 2

25B

17B



25A



26A

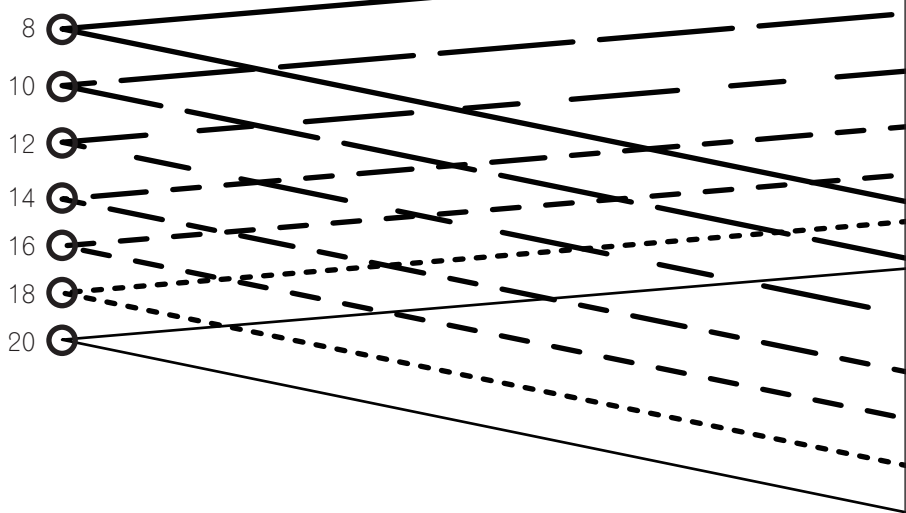

26B

18B

8

+  
+  
+  
+  
+  
+  
+

26A

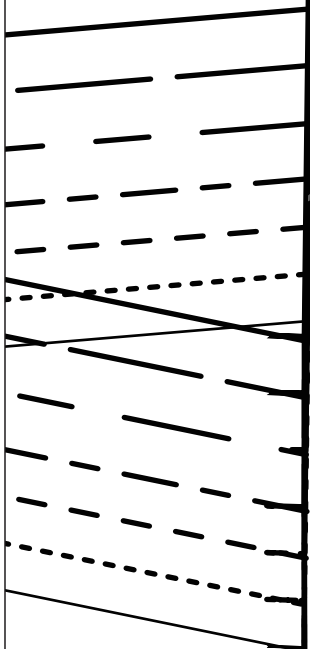

27B

19B

28B

28A

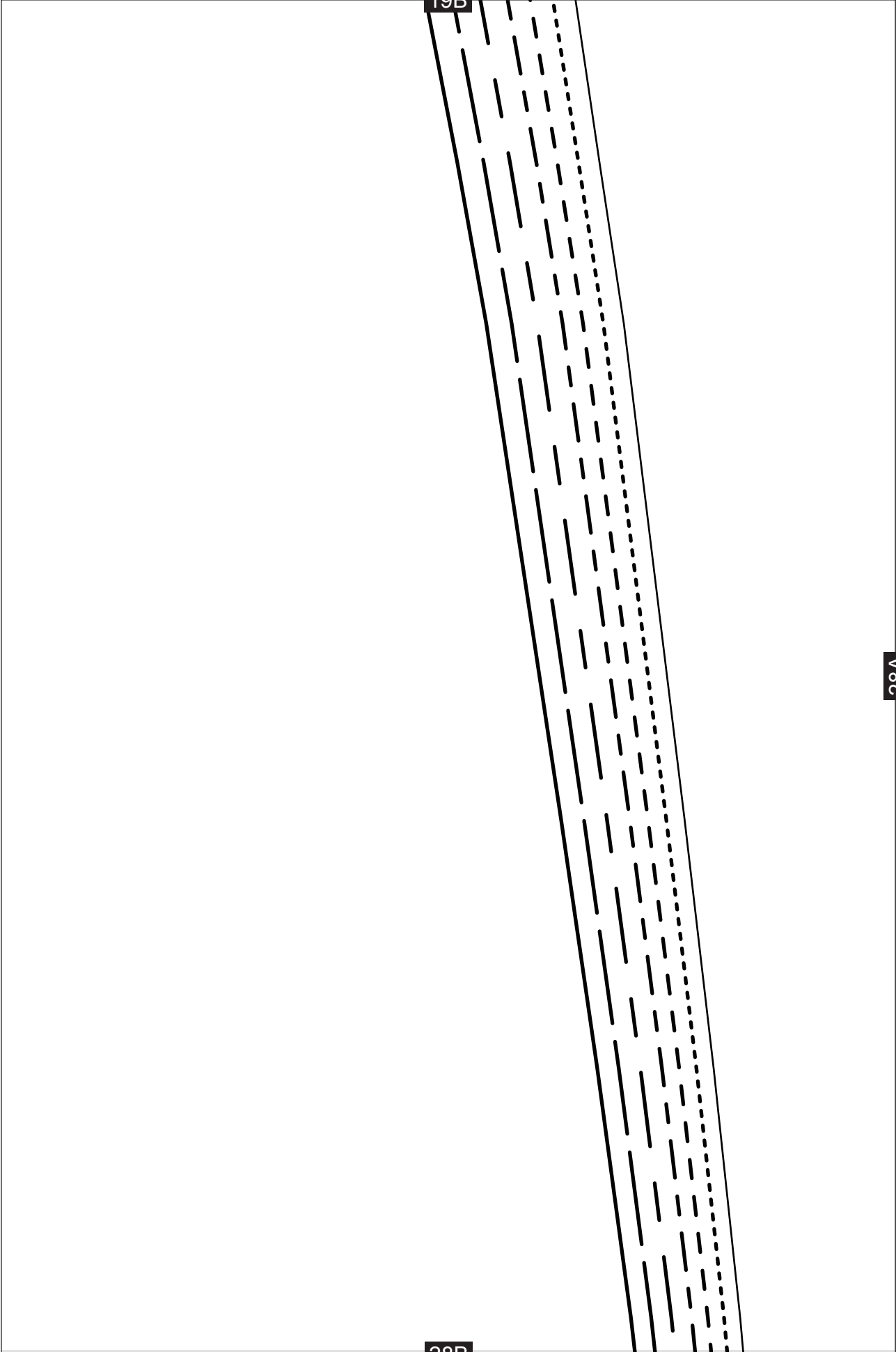

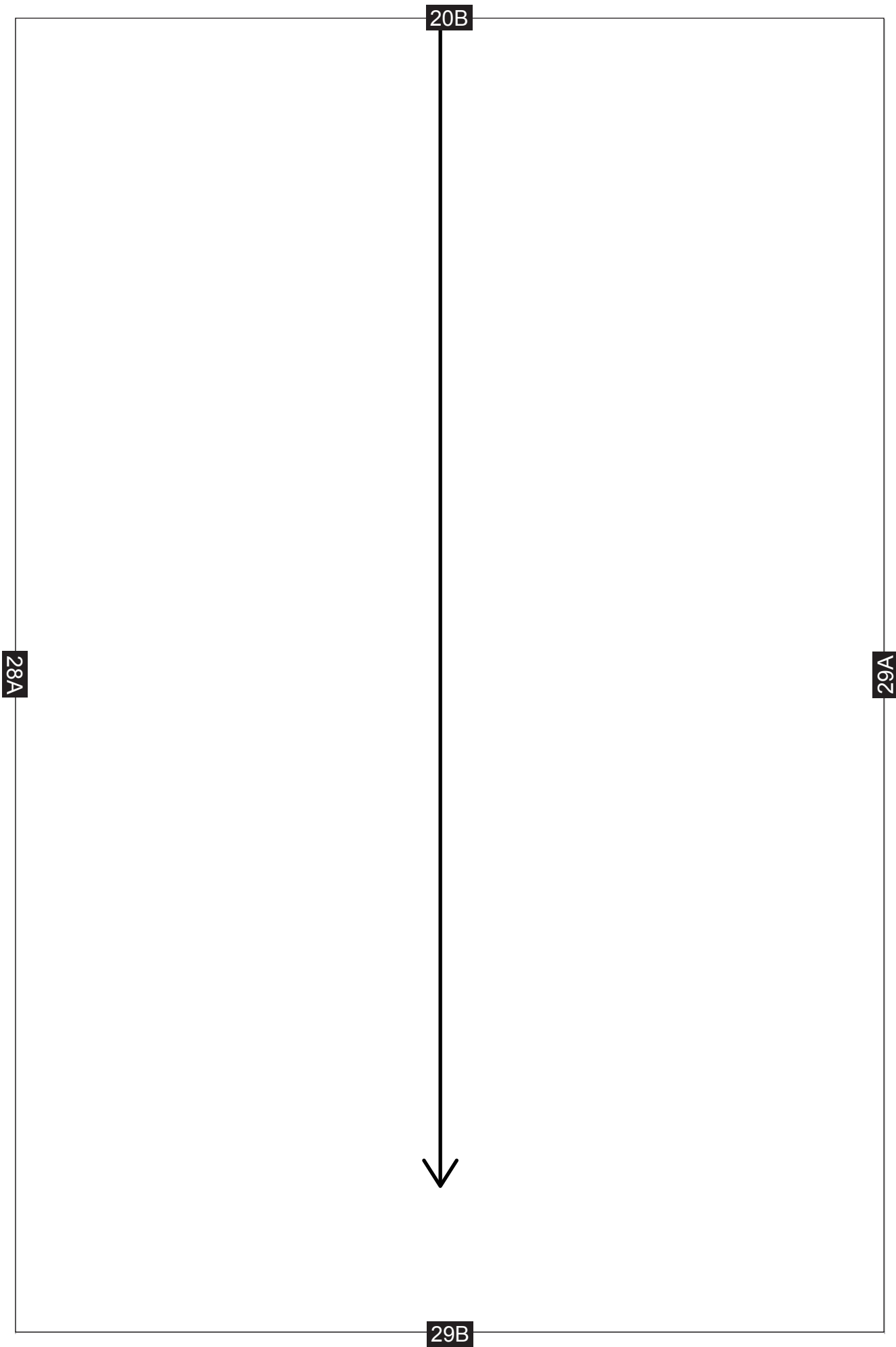

29A

21B

30A

30B

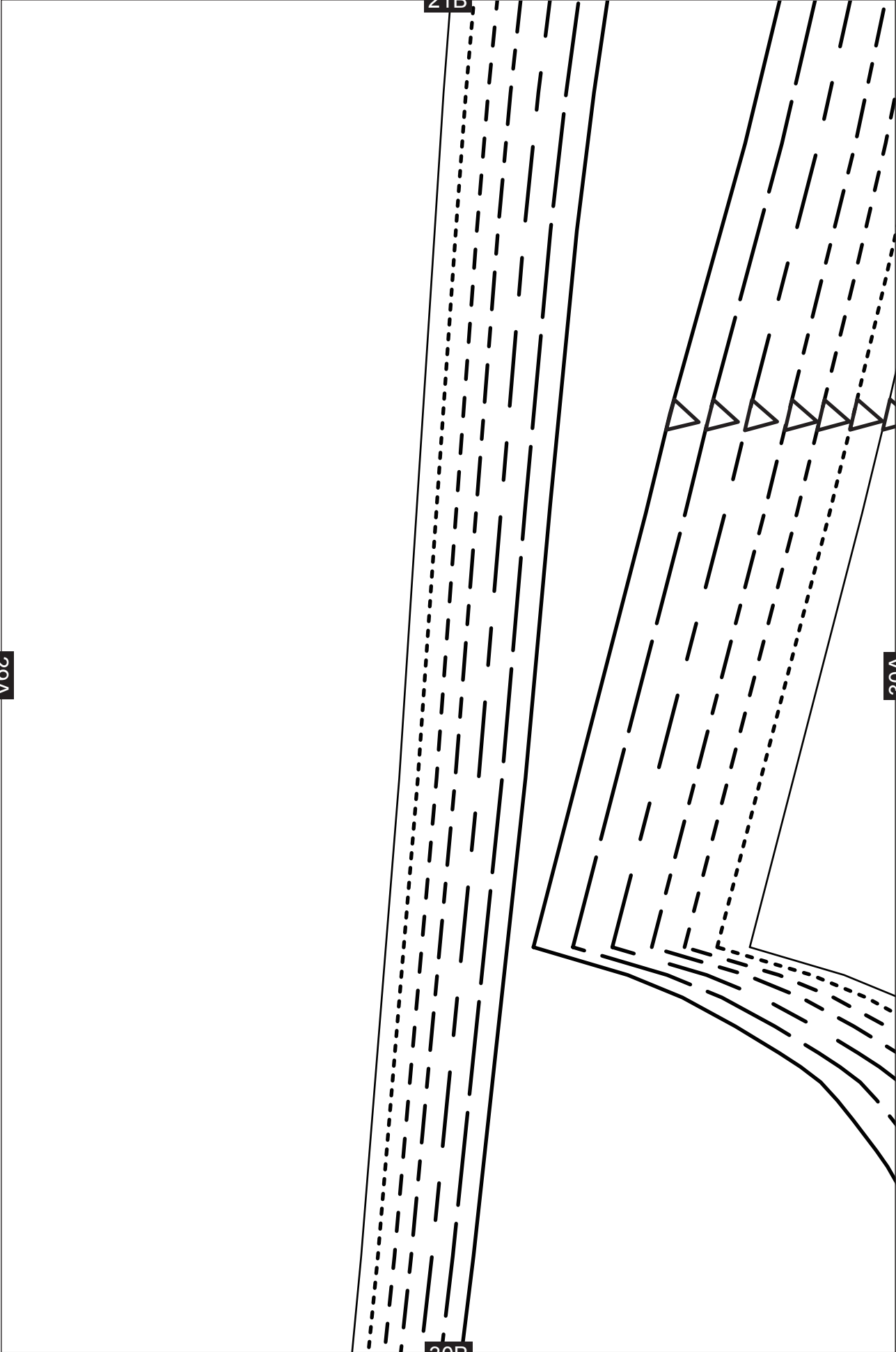

22B

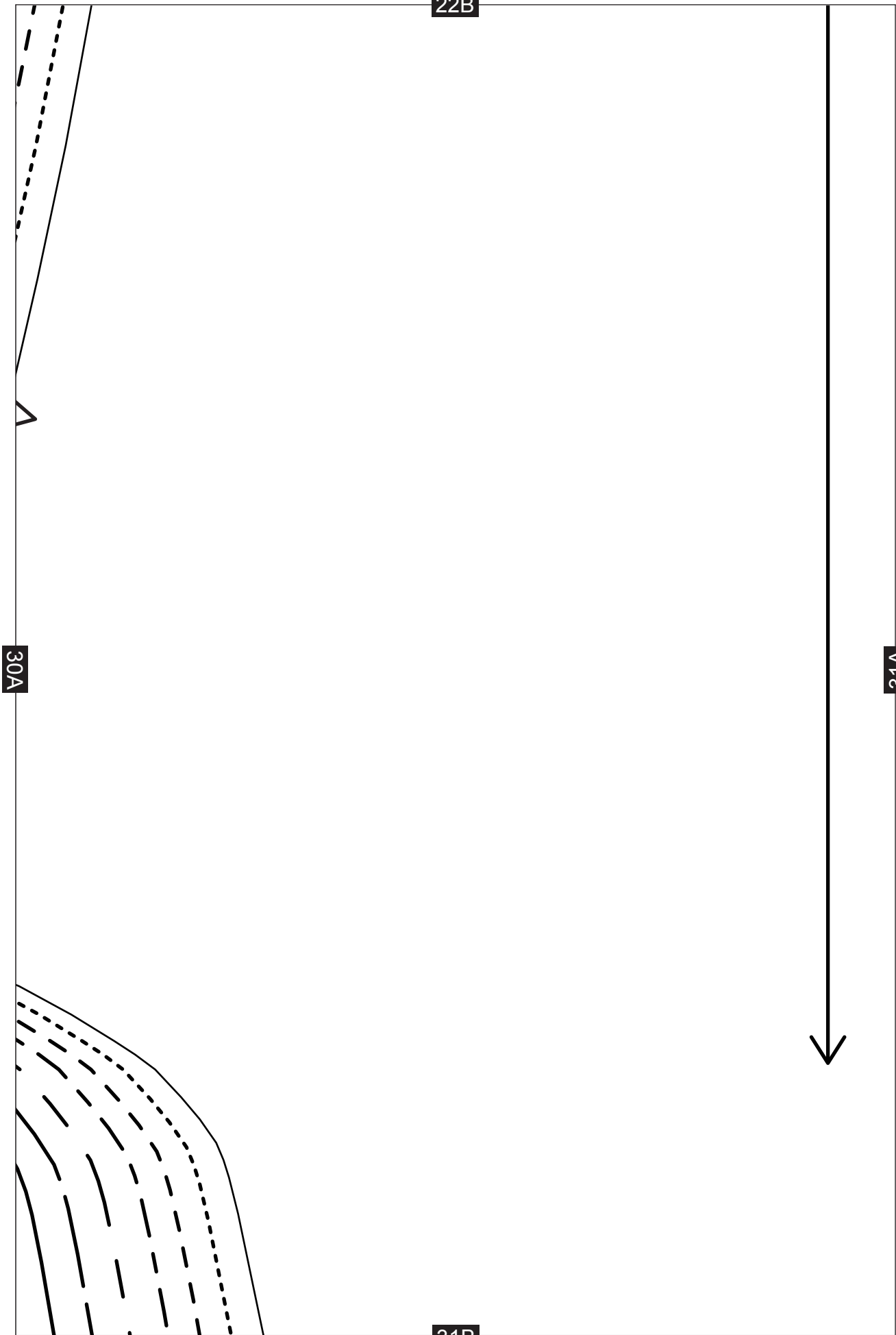

23B

31A

32A

32B

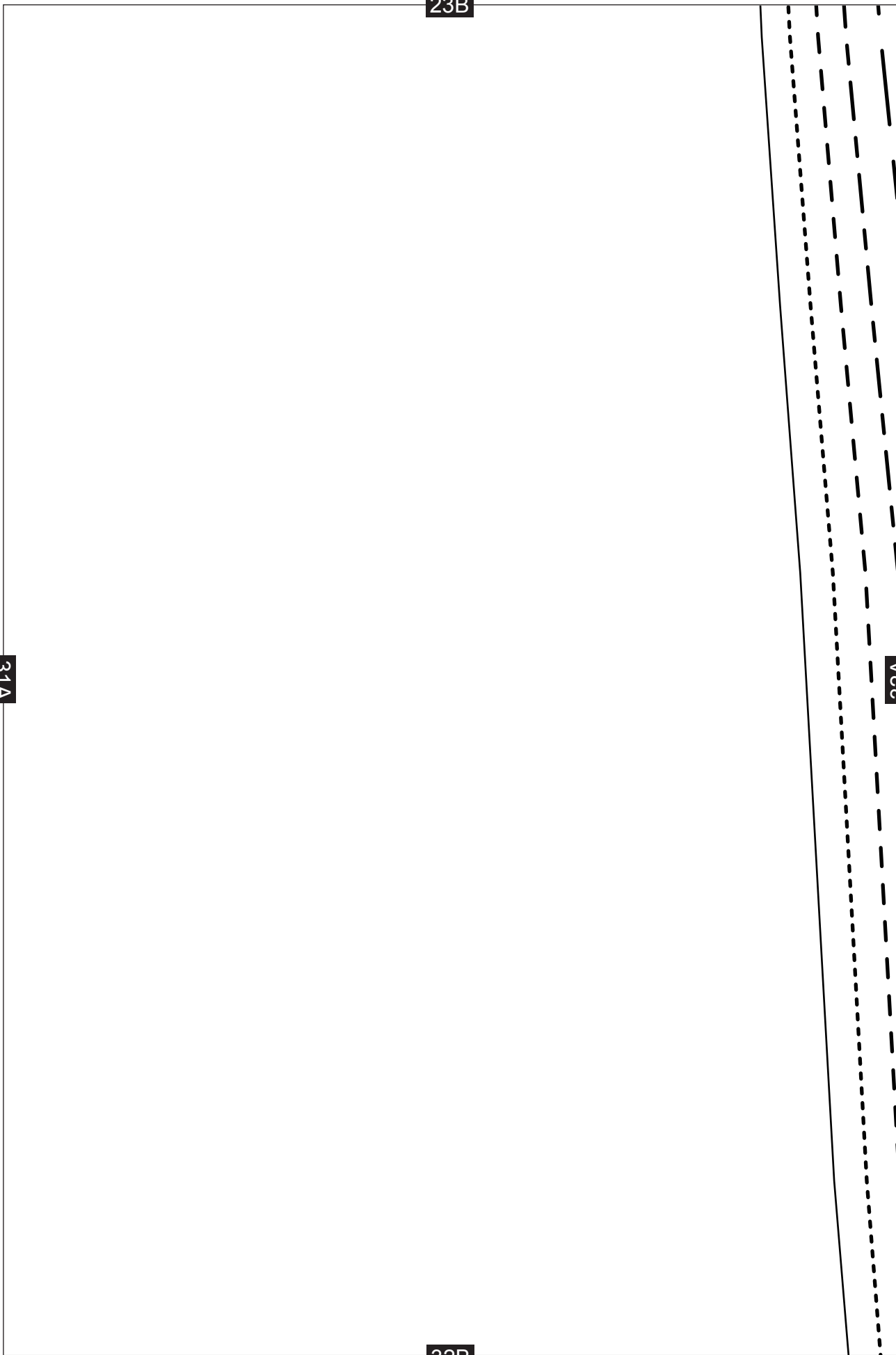



24B

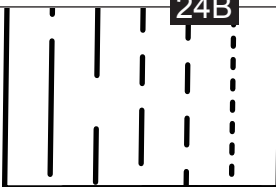

32A



33A

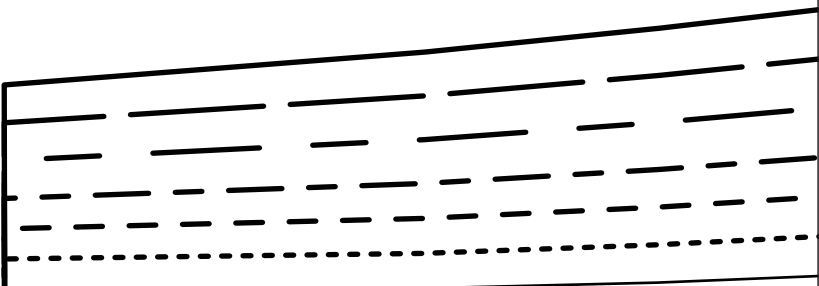

HEM 2.5 CM (1IN)

33B

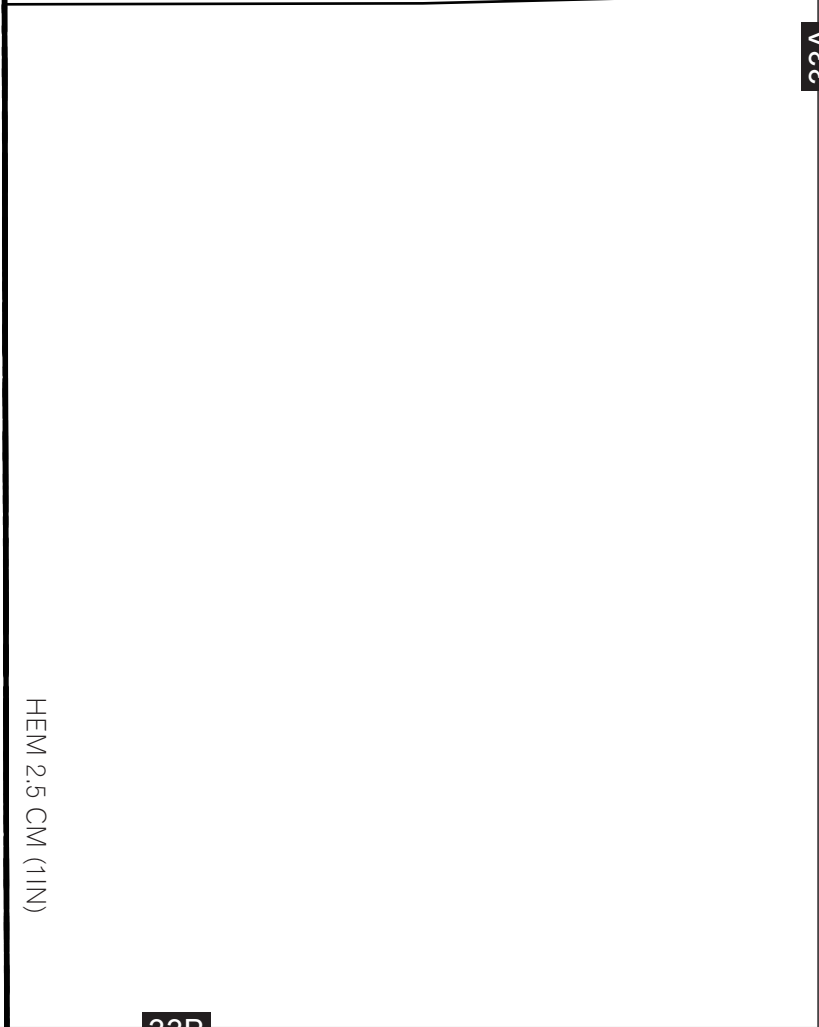

25B

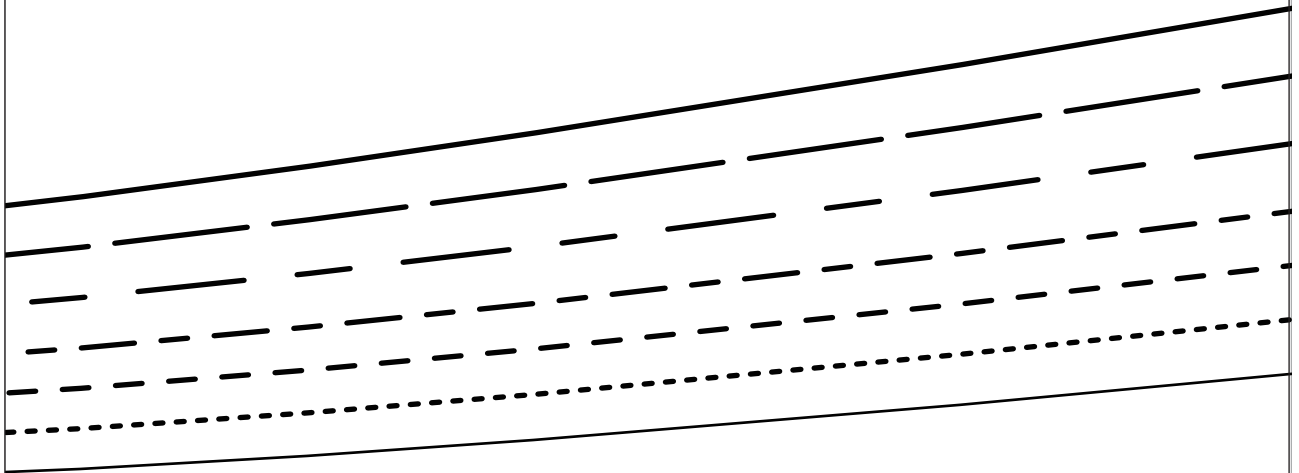

33A

34A

JUMPSUIT  
SLEEVE – CUT 2

34B

26B

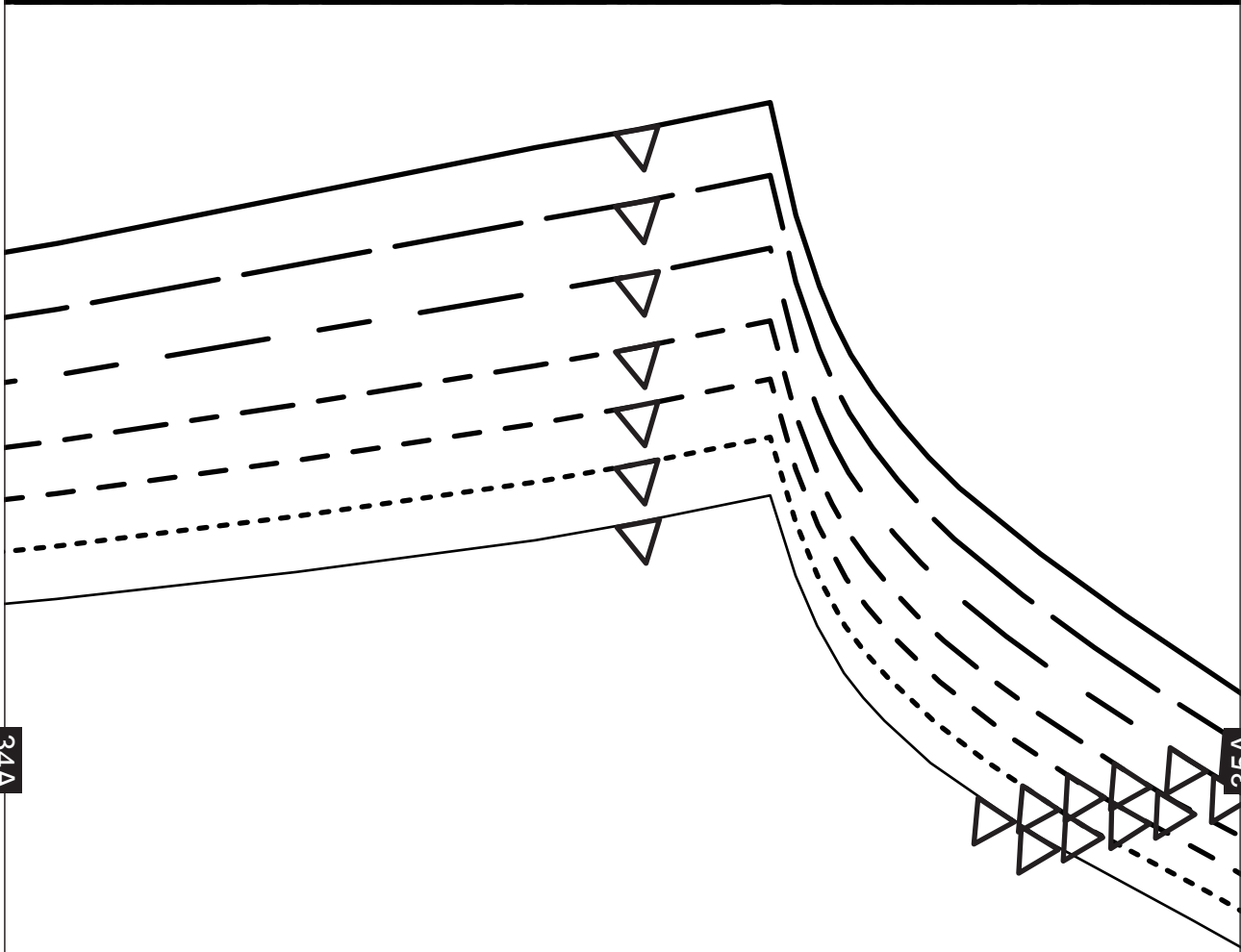

34A

35A

35B

27B

35A

36B

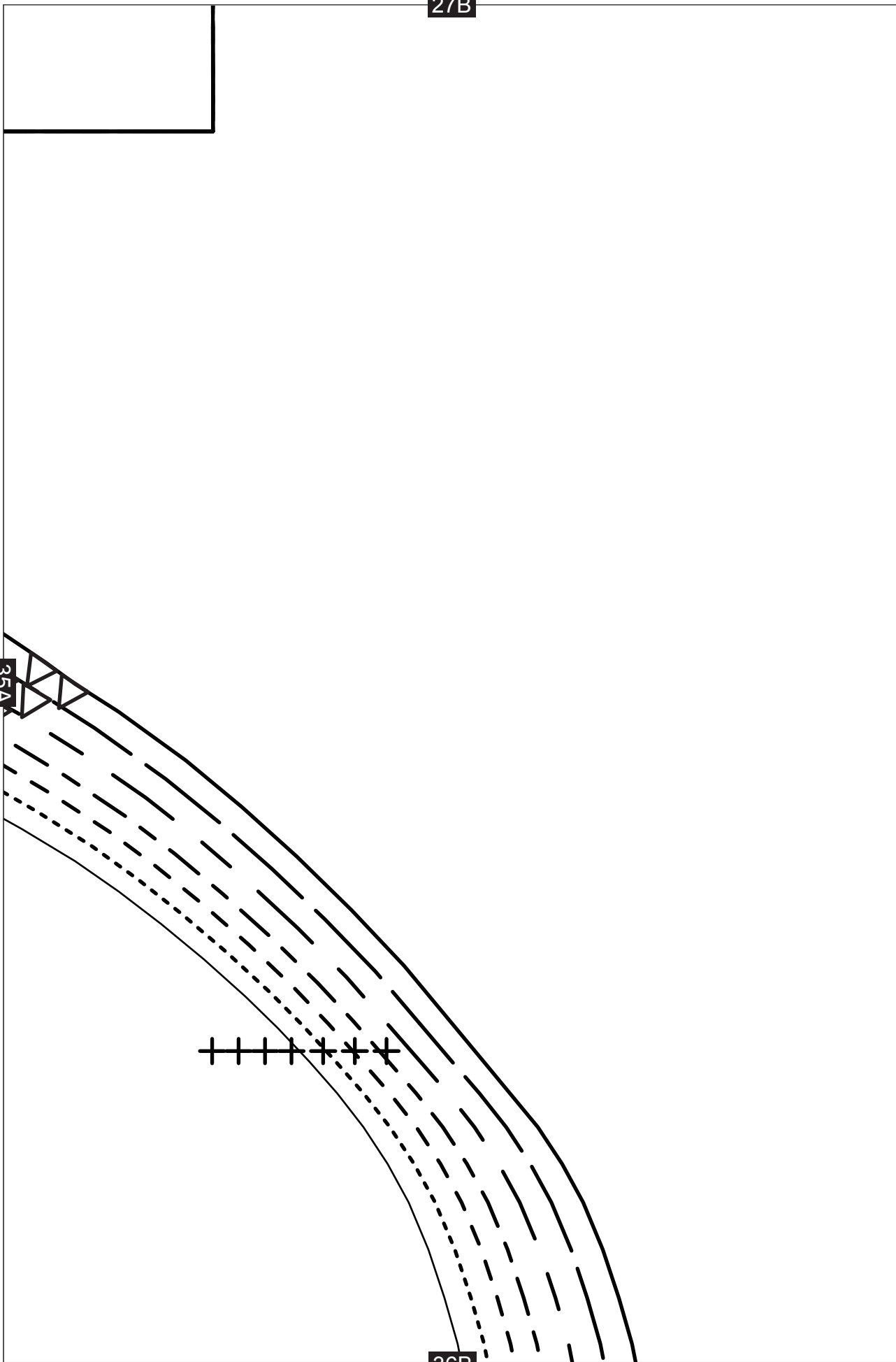

28B

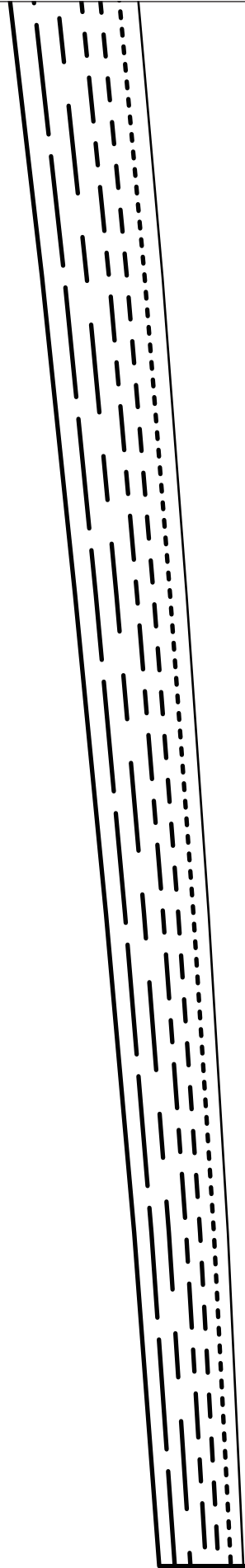

37A

29B

37A

38A

3 CM (1¼ IN.) HEM

38A

30B

39A

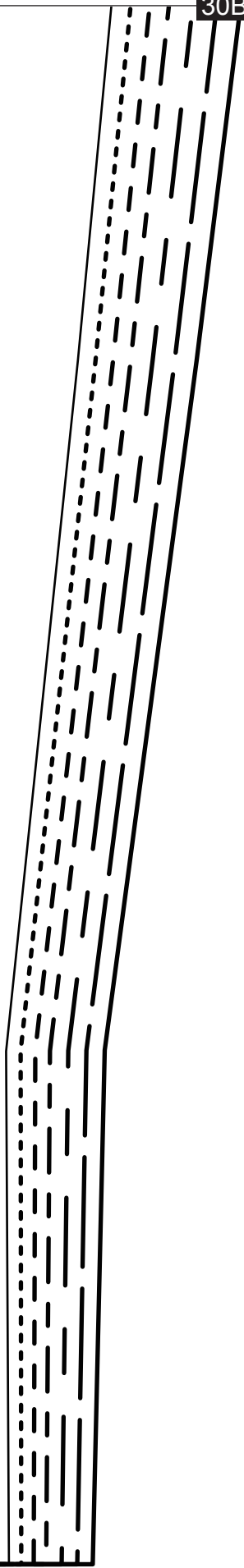

31B

39A

40A

WAISTLINE

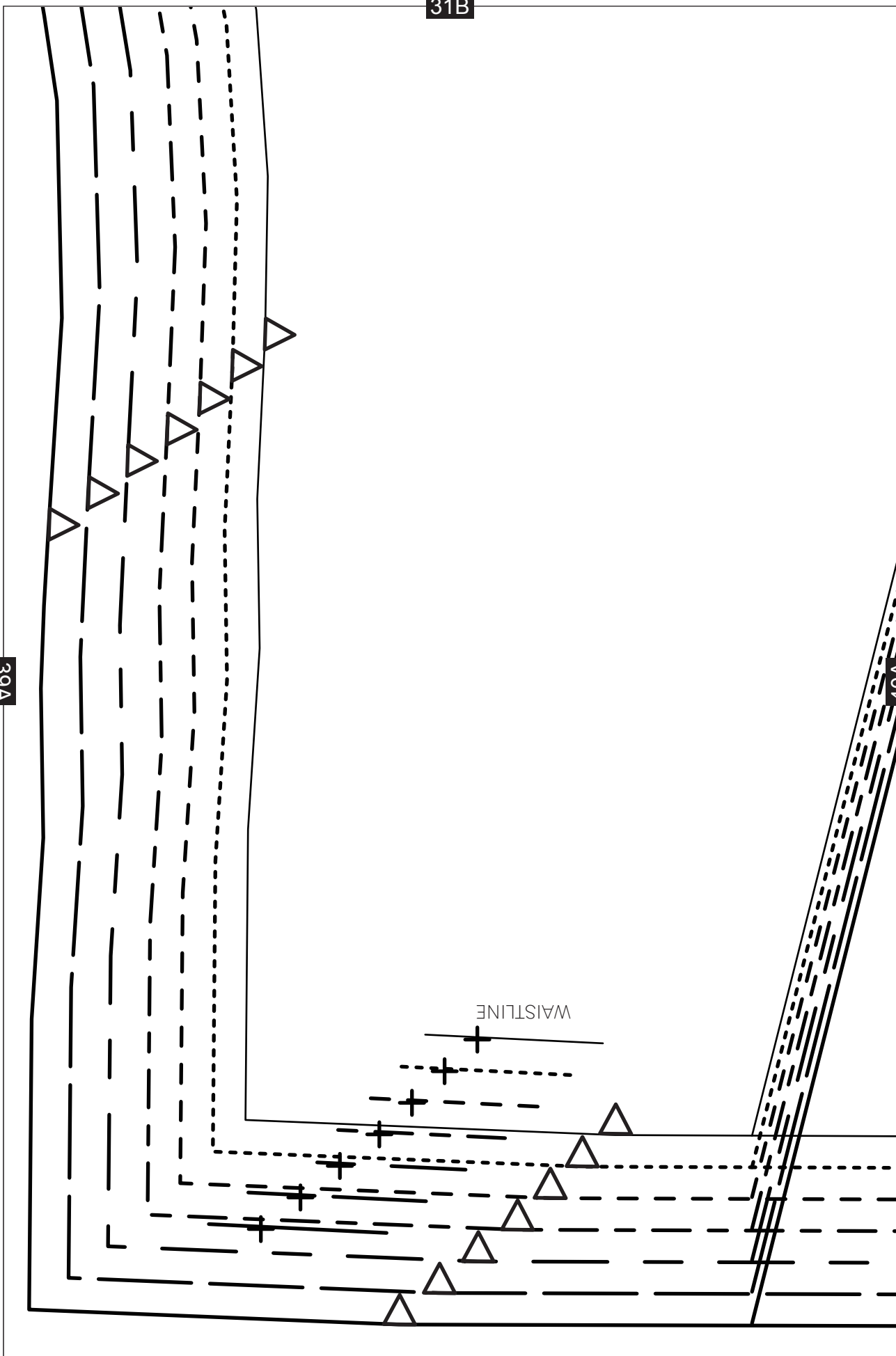



32B

41A

40A

JUMPSUIT  
TROUSER FRONT - CUT 2

8

10

12

14

16

18

20

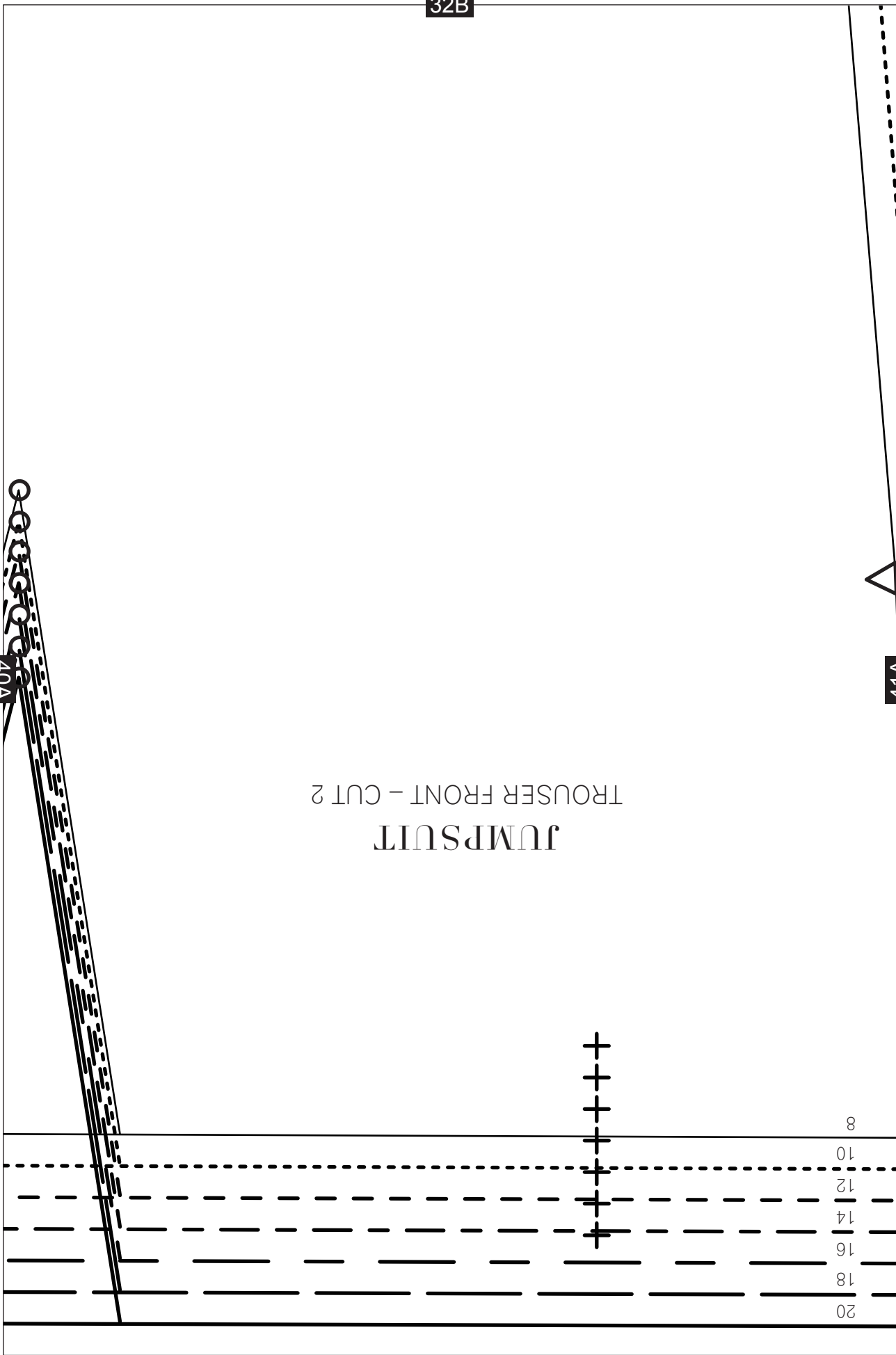

33B

42A

41A

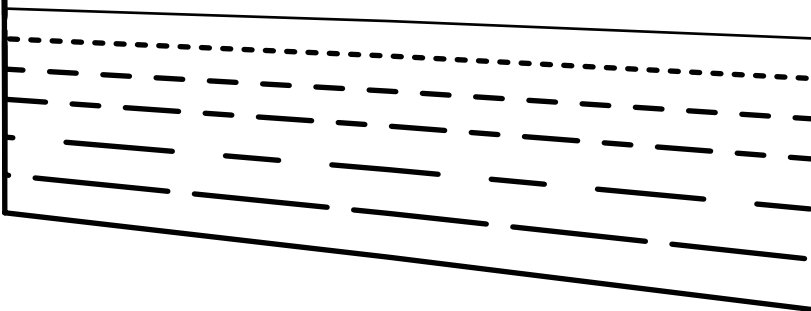
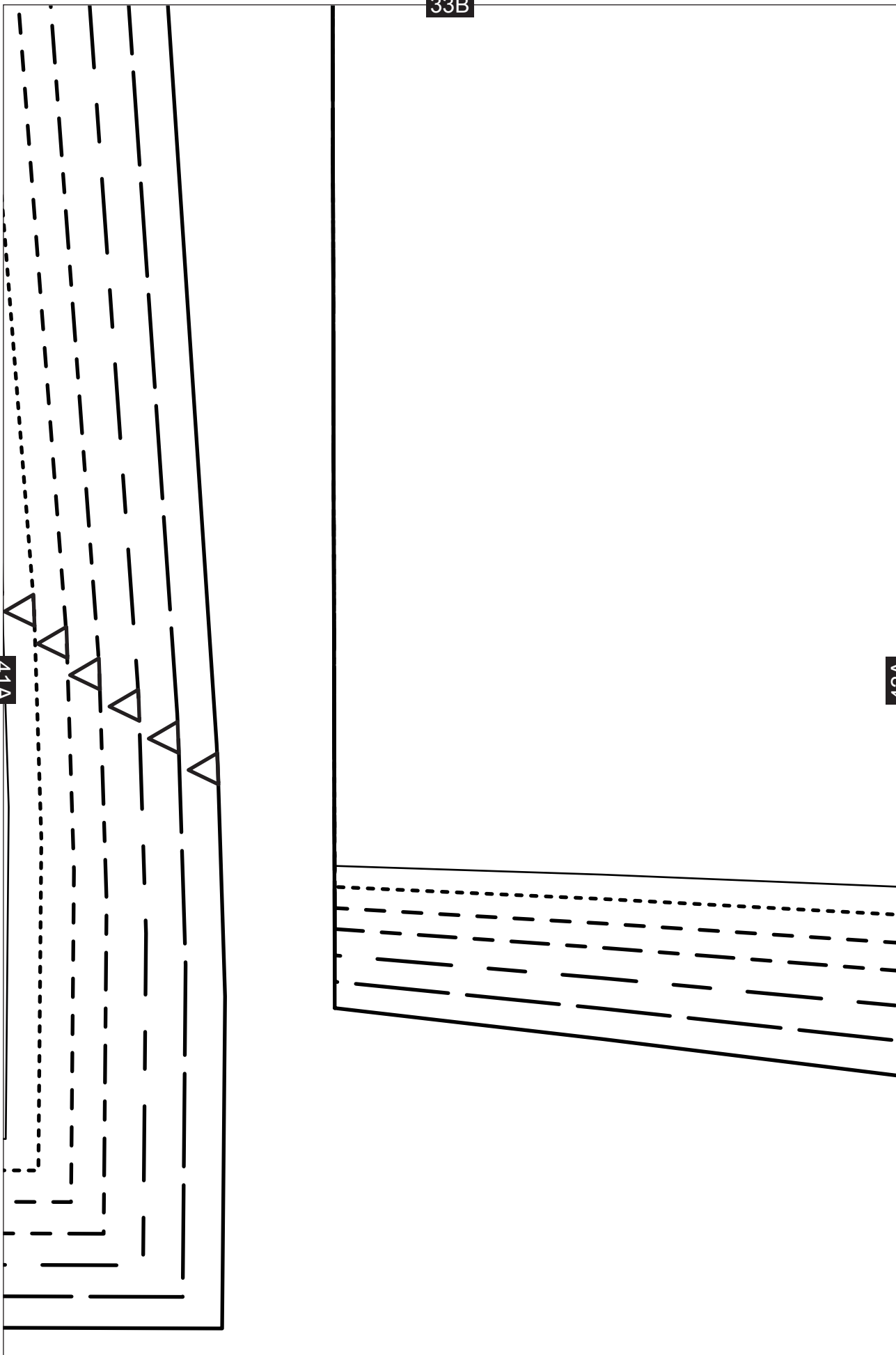

34B



42A

43A

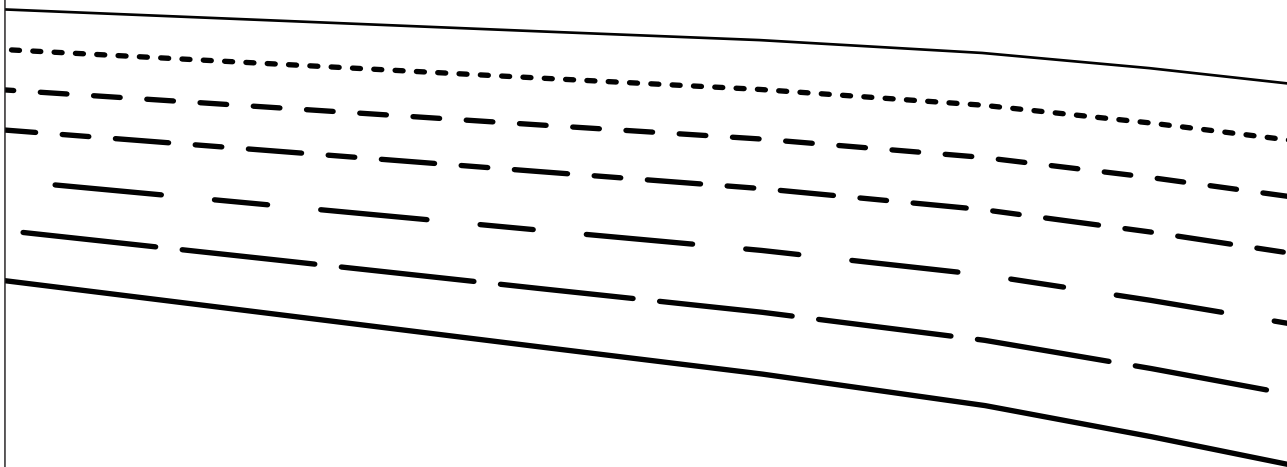

35B

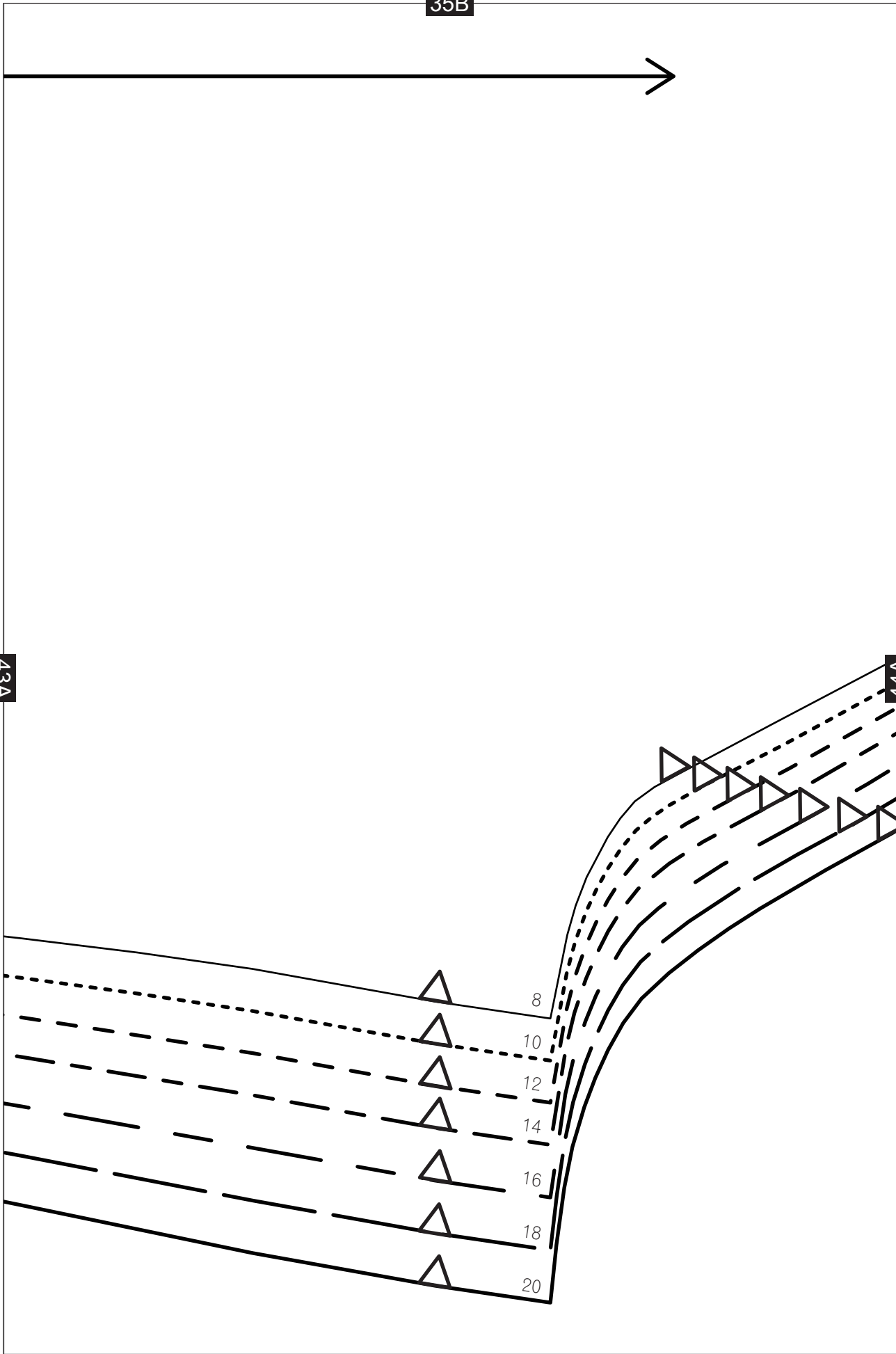

43A

44A

